



## Delhi High Court Reverses Abortion Approval Order

**For Prelims:** Medical Termination of Pregnancy, [MTP Amendment Act, 2021](#), Ambit of Article 21, Suchita Srivastava vs. Chandigarh Administration case, Roe V/s Wade case.

**For Mains:** Status of Medical Termination of Pregnancy in India, Key Features of MTP Amendment Act 2021.

[Source: TH](#)

### Why in News?

Recently, the [Delhi High Court](#) has reversed its order that permitted a **26-year-old woman** to terminate her 29-week-old [pregnancy](#).

- The court, now **advocating for the unborn child's right to life**, has directed the woman to undergo delivery at either AIIMS or any central or state hospital.

### What is the Status of Medical Termination of Pregnancy in India?

- **Background:** In the 1960s, in the wake of a high number of induced abortions taking place, the Union government ordered the constitution of the **Shantilal Shah Committee** to deliberate on the **legalisation of abortion in the country**
  - Resulting from its recommendations, the **Medical Termination of Pregnancy (MTP) Act, 1971** was enacted, permitting safe and legal abortions to protect women's health and decrease maternal mortality.
- **MTP Act and Subsequent Amendment:**
  - The **MTP Act, 1971** permits licensed medical professionals to perform **safe and legal abortions** in specific predetermined situations (as provided under the legislation), to protect women's health and decrease maternal mortality.
    - It underwent subsequent amendments through the [MTP Amendment Act, 2021](#).
- **Provisions for Terminating Pregnancy:**

Time Since Conception	MTP Act, 1971	MTP (Amendment) Act, 2021
<b>Up to 12 weeks</b>	On the advice of one doctor	On advice of one doctor
<b>12 to 20 weeks</b>	On advice of two doctors	On advice of one doctor
<b>20 to 24 weeks</b>	Not allowed	On advice of two doctors for special categories of pregnant women
<b>More than 24 weeks</b>	Not allowed	On advice of medical board in case of substantial fetal abnormality
<b>Any time during the pregnancy</b>	On advice of one doctor, if immediately necessary to save pregnant woman's life	On advice of one doctor, if immediately necessary to save pregnant woman's life

## Note

Under MTP Amendment Act 2021, special categories of women, includes survivors of rape, victims of incest and other vulnerable women like **differently abled and minors**.

### ▪ Other Key Features of MTP Amendment Act 2021:

- **Termination Due to Failure of [Contraceptive Method or Device](#):** The MTP Act permitted married women to terminate pregnancies up to 20 weeks in case of contraceptive method or device failure.
  - The MTP Amendment Act **extended the allowance to unmarried women as well**.
- **Medical Boards:** The board will assess pregnancies beyond 24 weeks for substantial foetal abnormalities.
  - It should comprise specialists like gynaecologists, paediatricians, and radiologists, and will be established by all state and union territory governments.
- **Privacy Measures:** A registered medical practitioner can only disclose details of a terminated pregnancy to **individuals authorised by law**. Violation carries penalties of **imprisonment up to a year, fines, or both**.

### ▪ Constitutional Stance:

- Although the **Constitution does not explicitly mention the right to abortion**, certain fundamental rights have been associated with **reproductive rights and women's healthcare**.
- **Article 21 - Right to Life and Personal Liberty:** The Supreme Court interprets this broadly to encompass reproductive autonomy and healthcare (**Suchita Srivastava vs. Chandigarh Administration case, 2009**)
  - Also, recently the **Supreme Court** observed that the **rights of an unborn child must be balanced with a woman's reproductive right**.

## Note

The fetus's moral status, legal standing, and constitutional rights still remain a grey area in India. However, **section 20 of the [Hindu Succession Act, 1956](#), protects the fetus's life from conception**.

### ▪ Global Trends:

- Worldwide, there is a noticeable trend toward the liberalisation of abortion laws and improved accessibility to abortion services.
- Since the early **1990s**, approximately **60 countries globally have relaxed abortion laws**, broadening the legal grounds for abortion.
- Notably, only four countries: the **United States, El Salvador, Nicaragua, and Poland**, have tightened abortion laws during this period by removing legal grounds for the procedure.
  - A significant development occurred in 2022 when the U.S. Supreme Court eliminated the constitutional right to abortion (**Roe v. Wade case**).

//

# ZYGOTE DEVELOPMENT

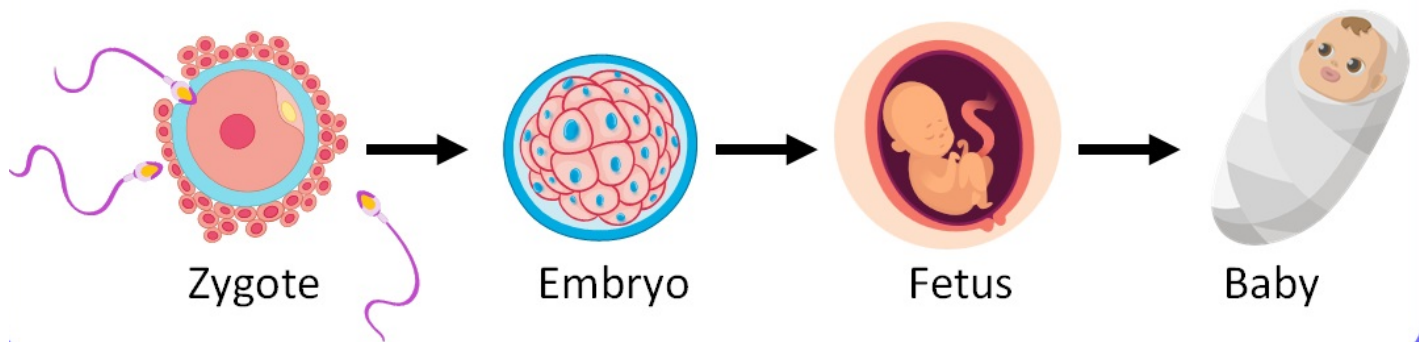

- **Zygote:** The initial cell formed by the fusion of sperm and egg during fertilisation.
- **Embryo:** Early stage of development, from the moment of fertilisation until about the 8th week of pregnancy.
- **Fetus:** The later stage of prenatal development, starting from the **ninth week until birth**, characterised by the development of organs and systems.

## UPSC Civil Services Examination, Previous Year Question:

### Mains

Q. What are the continued challenges for Women in India against time and space? (2019)

## Prohibition on Sapinda Marriage

**For Prelims:** [Hindu Marriage Act, 1955 \(HMA\)](#), Prohibition on Sapinda Marriage, Crime of incest, Closely Blooded Relations.

**For Mains:** Prohibition on Sapinda Marriage, Government policies and interventions for development in various sectors and issues arising out of their design and implementation.

[Source: IE](#)

## Why in News?

Recently, the Delhi High Court in the case of **Neetu Grover v. Union of India & Ors, 2024** has rejected a challenge to the constitutionality of **Section 5(v) of the [Hindu Marriage Act, 1955 \(HMA\)](#)**, which **prohibits marriage between two Hindus** if they are “Sapindas” of each other.

- A sapinda marriage involves **individuals who share a specific degree of familial closeness.**

## Why Was the Law Challenged, and What Was the Court's Ruling?

### ▪ Arguments of Petitioner:

- In 2007, the petitioner's marriage was **declared void after her husband successfully proved** that they had **entered into a sapinda marriage**, and that the woman was not from a community where such marriages could be considered a custom.
- The petitioner challenged the constitutional validity of the **prohibition on sapinda marriages, arguing** that sapinda marriages are **prevalent even when there is no proof of custom**.
- Hence, **Section 5(v) which prohibits sapinda marriages** unless there is an established custom, violates the right to equality under Article 14 of the Constitution.
  - The petitioner also argued that if the marriage had received the consent of both families, **which proved the legitimacy of the marriage**.

### ▪ Delhi Court's Order:

- The Delhi High Court found no merit in her arguments, holding that the petitioner did not **provide "stringent proof" of an established custom**, which is necessary to justify a sapinda marriage.
- The court held that the choice of a partner in a marriage **can be subject to regulation**. With this in mind, the court held that the petitioner did not present any **"cogent legal ground"** to show that the prohibition against sapinda marriages was violative of the right to equality.

## What is a Sapinda Marriage?

### ▪ About:

- A sapinda marriage is one **between individuals who are related to each other** within a **certain degree of closeness**.
- Sapinda marriages are defined under **Section 3 of the HMA**, as two persons are said to be "sapindas" of each other if one is a lineal ascendant of the other in the limits of sapinda relationship, or if they have a common lineal ascendant who is within the limits of sapinda relationship with reference to each of them.

### ▪ Lineal Ascendant:

- Under the provisions of the HMA, on the mother's side, a Hindu individual cannot marry anyone **who is within three generations of them in the "line of ascent"**. On the father's side, this prohibition applies to anyone within five generations of the individual.
- In practice, this means that on their mother's side, an individual cannot marry **their sibling (first generation)**, their parents (second generation), their grandparents (third generation), or an individual who shares **this ancestry within three generations**.
- On their father's side, this prohibition would extend up to their grandparents' grandparents, and anyone who shares this ancestry within five generations.

## Sapinda Relationship

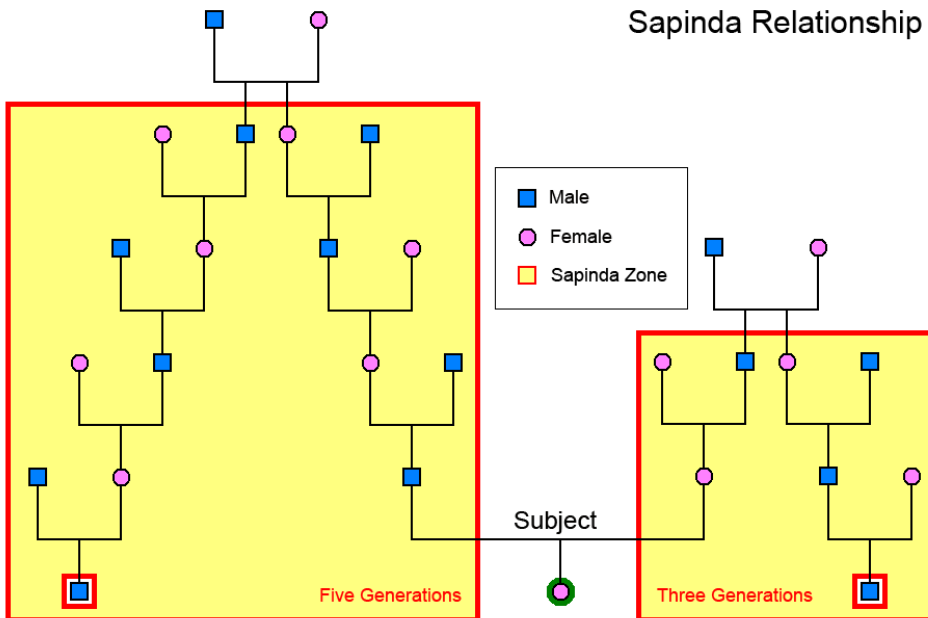

### ▪ Section 5(v) of HMA 1955:

- If a marriage is found to violate Section 5(v) for being a sapinda marriage, and there is no established custom that **allows such a practice, it will be declared void.**
- This would mean that the marriage was invalid from the very beginning, and will be treated as though it never took place.

## Legal Provisions Related to Marriage

- The Constitution of India guarantees the [right to life and personal liberty under Article 21](#), which includes the **right to marry a person of one's choice.**
- [The Special Marriage Act of 1954](#) allows any person to register and **solemnize their marriage with a person of their choice.**
- The **Supreme Court of India has dealt with several cases** involving the marriage of person of his/her choice. Like:
  - [Lata Singh v. State of U.P., 2006](#): The Court held that the right to marry a person of one's choice is a fundamental right under Article 21, and that no one, including the parents or the community, can interfere with or object to such marriages.
  - [Shakti Vahini v. Union of India, 2018](#): [The Supreme Court](#) held that consensually choosing life partners is a manifestation of their freedom of choice guaranteed under [Articles 19 and 21 of the Constitution.](#)

## What are the Exceptions to the Prohibitions Against Sapinda Marriages?

- The exception is mentioned in Section 5(v) of the Hindu Marriage Act, 1955 and it states that **if the customs of the individuals involved permit sapinda marriages, then such marriages would not be declared void.**
- In other words, if there is an established custom within the community, tribe, group, or family that allows sapinda marriages, and if this custom is continuously and uniformly observed for a long time, it can be **considered a valid exception to the prohibition.**
  - The definition of "**custom**" is provided in **Section 3(a) of the HMA**, stating that a custom must be continuously and **uniformly observed for a long time and should have gained enough legitimacy among Hindus in a local area**, tribe, group, or family, such that it has obtained "the force of law."
- However, **certain conditions must be met for a custom to be considered valid.** The rule in question must be "certain and not unreasonable or opposed to public policy," and in the case of a

rule applicable only to a family, it should not have been "discontinued by the family."

- If these **conditions are satisfied**, and there is a valid custom permitting sapinda marriages, the marriage would **not be declared void under Section 5(v) of the HMA.**

## Are Marriages Similar to Sapinda Marriages Allowed in Other Countries?

### ▪ France and Belgium:

- In France and Belgium, the **crime of incest** was abolished under the **Penal Code of 1810**, allowing marriages between consenting adults.
  - Incest is the crime of sexual relations or marriage taking place between a male and female who are **closely linked by blood.**
- Belgium maintained this legal stance even after introducing a new Penal Code in 1867.

### ▪ Portugal:

- Portuguese law does not criminalise incest, implying that marriages between close relatives **may not be prohibited.**

### ▪ Republic of Ireland:

- While the Republic of Ireland recognised same-sex marriages in 2015, the law on **incest has not been updated to explicitly** include individuals in same-sex relationships.

### ▪ Italy:

- In Italy, incest is considered a crime only if it causes a "**public scandal**," suggesting that the legal framework takes into account certain circumstances.

### ▪ United States:

- In the United States, incestuous marriages are generally banned in all 50 states. However, there are variations in laws related to incestuous relationships between consenting adults.
  - For example, New Jersey and Rhode Island **allow such relationships under certain conditions.**

## Conclusion

- The concept of Sapinda marriages, as regulated by the HMA, reflects an effort **to preserve familial and social harmony** by prohibiting unions within certain lineal ascendants. The law includes provisions that declare marriages **void if they violate these restrictions unless there is a well-established custom** permitting such marriages.
- Internationally, various countries have different legal stances on incestuous relationships and marriages, showcasing the diversity of legal approaches to issues of personal choice and family relationships.

**Legal Insight:** [Prohibition on Marriage within Sapinda Relationships](https://www.drishtijudiciary.com/en)

<https://www.drishtijudiciary.com/en>

## UPSC Civil Services Examination, Previous Year Question (PYQ)

**Q. In the context of Indian history, the Rakhmabai case of 1884 revolved around (2020)**

1. women's right to gain education
2. age of consent
3. restitution of conjugal rights

**Select the correct answer using the code given below:**

- (a) 1 and 2 only  
(b) 2 and 3 only

- (c) 1 and 3 only  
(d) 1, 2 and 3

Ans: (b)

Exp:

- Rakhmabai (1864 - 1955) made her mark in history due to the legal case she was involved in, which contributed to the enactment of the Age of Consent Act, 1891.
- In 1885, after 12 years of marriage, her husband sought “restitution of conjugal rights”, Rakhmabai was ordered to go live with her husband or spend six months in jail. Hence, 3 is correct.
- Rakhmabai refused to live with the man she was married to as a child, as she had no say in the marriage. Rakhmabai wrote to Queen Victoria. The Queen overruled the court’s verdict and dissolved the marriage.
- The ripples that the case created led to the influence on the passage of the Age of Consent Act, 1891, which made child marriages illegal across the British Empire. Hence, 2 is correct.
- Though Rakhmabai became the first women doctor to practice medicine in British India, the case was not related to the women’s right to gain education. Hence, 1 is not correct.
- Therefore, option B is the correct answer.

---

## Aadhaar is Not a Proof of Citizenship

**For Prelims:** [Aadhaar](#), [Citizenship](#), [Election Commission of India](#), [Citizenship Act of 1955](#)

**For Mains:** Issues Arising Out of Design & Implementation of Policies, Concerns regarding the use of Aadhaar.

**Source:** [TH](#)

### Why in News?

The Indian government has recently emphasized that [Aadhaar](#) is not proof of [citizenship](#) or date of birth (D.O.B).

- The new Aadhaar cards and PDF versions of the identity document have started including a more explicit and prominent disclaimer that they are “**a proof of identity, not of citizenship or date of birth,**” signalling to government departments and other organizations to not use it for those purposes.

### What are the Legal Clarifications on the Use of Aadhaar as an Identity Document?

- **Bombay High Court:**
  - Bombay High Court in **State of Maharashtra vs Unique Identification Authority of India (UIDAI) Case, 2022** clarified the scope and limitations of Aadhaar as an identity document. The Court stated that **Aadhaar is only a proof of identity and residence, not of citizenship or date of birth.**
- **Supreme Court of India:**
  - The [Supreme Court of India](#) in the case of [Justice K.S. Puttaswamy \(Retd.\) and Anr.](#)

[vs Union Of India, 2018](#) has upheld the constitutional validity of Aadhaar.

- The Court also clarified that **Section 9 of the Aadhaar Act, 2016** states that "The Aadhaar number or the authentication thereof **shall not, by itself, confer any right of, or be proof of, citizenship or domicile** in respect of an Aadhaar number holder".
- **Ministry of Electronics and Information Technology (MeitY):**
  - MeitY clarified in a 2018 memorandum that Aadhaar is "**per se ... not a proof of date of birth,**" as the **date of birth is based on a different document given by Aadhaar applicants.**
- **Employees' Provident Fund Organisation (EPFO):**
  - The [EPFO](#) which administers the mandatory retirement fund for salaried employees in India.
    - The EPFO issued a circular in January 2024 **deleting Aadhaar from the list of documents acceptable as a proof of date of birth.**

## Aadhaar

- Aadhaar is a **12 digit individual identification number** issued by the [Unique Identification Authority of India \(UIDAI\)](#) on behalf of the Government of India. The number serves as a **proof of identity and address**, anywhere in India.
- Aadhaar card, which is a biometric document, **stores an individual's personal information on a government database.**
- An Aadhaar card can be issued to any person **residing in the country for more than six months continuously**, provided he/she submits one of the 18 listed identity cards and an address proof.
  - Foreign nationals are eligible to obtain one **if they have been living in India for half a year.**
- Aadhaar number will help the residents to avail various services provided by banking, mobile phone connections and other Govt and Non-Govt services in due course.

## What are the Concerns Regarding the Aadhaar?

- **Usage of Aadhaar as Proof of Citizenship or D.O.B:**
  - The [Election Commission of India](#) explicitly accepts Aadhaar as proof of date of birth for enrolling people to vote.
    - These new clarifications on Aadhaar usage, prominently printed in the identity document, may challenge such allowances.
- **Privacy and Security:**
  - Aadhaar involves the collection and **storage of sensitive personal information**, such as fingerprints, iris scans, and face photos, which **raises the risk of data breaches, identity theft, and surveillance.**
- **Biometric Authentication:**
  - Aadhaar relies on **biometric verification for accessing services**, which poses challenges such as the **reliability and accuracy of the technology**, the availability and quality of the infrastructure, and the exclusion and **denial of services due to biometric failures.**

## Citizenship

- Citizenship is the legal status and **relationship between an individual and a state** that entails specific rights and duties.
- The [Citizenship Act of 1955](#) prescribes five ways of acquiring citizenship, viz, [birth, descent, registration, naturalization and incorporation of territory](#).
  - **The Act** also deals with renunciation of citizenship by way of [termination, deprivation and Voluntary Renunciation](#).
- The Indian Constitution defines **citizenship in Part II**, which includes **Articles 5 to 11.**



- Citizenship is listed in the **Union List under the Constitution** and thus is under the exclusive jurisdiction of Parliament.
- A **birth certificate in India** can serve as proof of identity, age, and Indian citizenship.
  - According to the [Registration of Births and Deaths Act, 1969](#), births must be registered within 21 days.

## Way Forward

- Launch extensive **awareness campaigns to educate the public, government departments, and organizations** about the revised and **explicit disclaimer on Aadhaar cards**.
  - Emphasize that **Aadhaar is solely a proof of identity and residence**, and not a document verifying citizenship or date of birth.
- Conduct a comprehensive **reassessment of Aadhaar's role and permissible uses**, considering legal, privacy, and security concerns.
- Implement robust **data security measures to safeguard sensitive information** stored in the Aadhaar database.
- Explore innovative solutions to improve the **reliability and accuracy of biometric verification**, reducing instances of failures and exclusions.
- Encourage collaborative efforts to enhance the overall effectiveness and inclusivity of the Aadhaar system.

## UPSC Civil Services Examination, Previous Year Questions (PYQs)

### Q. Consider the following statements: (2018)

1. Aadhaar card can be used as a proof of citizenship or domicile.
2. Once issued, Aadhaar number cannot be deactivated or omitted by the Issuing Authority.

### Which of the statements given above is/are correct?

- (a) 1 only  
 (b) 2 only  
 (c) Both 1 and 2  
 (d) Neither 1 nor 2

**Ans: (d)**

### Mains:

**Q.** Two parallel run schemes of the Government, viz the Aadhaar Card and NPR, one as voluntary and the other as compulsory, have led to debates at national levels and also litigations. On merits, discuss whether or not both schemes need run concurrently. Analyse the potential of the schemes to achieve developmental benefits and equitable growth. **(2014)**

## India-France Relations

**For Prelims:** [Republic Day \(26<sup>th</sup> January\)](#), [Indo-Pacific Region](#), [Indian Ocean Region](#), [Indo-Pacific Triangular Development Cooperation Fund](#).

**For Mains:** India-France Cooperation, Bilateral, regional and global groupings and agreements involving India and/or affecting India's interests.

[Source: TH](#)

## Why in News?

Recently, the President of France visited India on the Occasion of **Republic Day (26<sup>th</sup> January)**, where India and France discussed Bilateral cooperation, expressing satisfaction with the increasing “complexity and interoperability” of India-France joint defence exercises.

## What are the Key Highlights of the India-France Bilateral Meeting?

- **Intensification of Cooperation in Southwest Indian Ocean:**
  - Both countries agreed to **intensify cooperation in the Southwest Indian Ocean**, building on joint surveillance missions carried out **from the French island territory of La Reunion** in 2020 and 2022.
  - This cooperation contributes **positively to the securitisation** of strategic **sea lanes of communication**.
- **Indo-Pacific Partnership:**
  - Both sides emphasized the **significance of the [Indo-Pacific Region](#)** for their sovereign and strategic interests.
  - They committed to **deepening the long-standing partnership** in the Indo-Pacific, based on their common vision, and expressed satisfaction with the expanding **nature of their engagement in the region**.
- **Defence and Security Partnership:**
  - The defence and security partnership between India and France in the Indo-Pacific region was highlighted as a cornerstone of their collaboration.
  - This partnership includes a comprehensive range of bilateral, multinational, regional, and institutional initiatives, especially in the **[Indian Ocean Region](#)**.
  - The leaders **discussed joint tri-services exercises** and increasing capacities, particularly in the **maritime domain**.
- **Trilateral Cooperation:**
  - Both countries committed to **revitalising trilateral cooperation with Australia**, deepening cooperation with the **United Arab Emirates (UAE)**, and exploring new trilateral **partnerships in the region**.
    - In June 2023, the first edition of **[India, France and UAE Maritime Partnership Exercise](#)** commenced in the Gulf of Oman.
- **Economic Development and Connectivity:**
  - Both countries acknowledged the importance of joint and multilateral initiatives for supporting sustainable economic development, human welfare, environmental sustainability, resilient infrastructure, innovation, and connectivity in the region.
  - They called for the early launching of the **[Indo-Pacific Triangular Development Cooperation Fund](#)** to facilitate the scaling up of green technologies.
- **India-Middle East-Europe Corridor (IMEC):**
  - The leaders recalled the launch of the **[India-Middle East-Europe Corridor \(IMEC\)](#)**, considering it of great strategic importance for enhancing the potential and resilience of commerce and energy flow between India, the **[Middle East](#)**, and Europe.
- **Multilateralism and UN Reform:**
  - Both countries called for **reformed and effective multilateralism**, stressing the urgent need for the reform of the **[United Nations Security Council \(UNSC\)](#)**.
    - France reiterated its support for India's permanent membership in the UNSC.
  - Both Sides highlighted the need for the reform of **Multilateral Development Banks** and welcomed the report submitted by the Independent Expert Group for providing concrete suggestions in this regard.
  - They acknowledged enhanced cooperation between the **[Paris Club](#)** and **India** in official

debt restructuring cases.

#### ▪ **Defence Industrial Cooperation:**

- Both sides reiterated their commitment to **deepening integration between the two countries' defense industrial sectors**. They discussed co-design, co-development, and co-production opportunities for defence supplies, not only for India but also for other friendly countries.

- **Tata Group and Airbus Agreement:**

- **Tata Group and Airbus** signed an agreement for the development and manufacturing of **civilian helicopters**.

- Tata and Airbus are already cooperating to make the **C-295 Transport Aircraft** in Gujarat.

- The industrial partnership aims to produce **H125 helicopters with a significant indigenous** and localization component.

- **Shakti Jet Engine Deal:**

- Ongoing discussions between India and **Safran regarding the Shakti jet engine deal** were highlighted. The focus of these discussions is on achieving specifications aligned with India's future fighter jet requirements, involving aspects beyond just the transfer of manufacturing technology.

- **CFM International and Akasa Air:**

- French jet engine maker CFM International also announced an agreement with India's Akasa Air to buy **more than 300 of its LEAP-1B engines** to power 150 Boeing open new tab 737 MAX aircraft.

#### ▪ **Space Cooperation:**

- The countries launched the **Strategic Space Dialogue**, signed a Letter of Intent on Defence Space Cooperation, and an MoU between **ISRO's New Space India Limited (NSIL)** and **Arianespace of France** for satellite launch missions.
- The leaders expressed dedication to expanding space cooperation, including co-development, manufacture, and launch of satellites.



### **What are the Major Areas of Cooperation between India and France?**

#### ▪ **Pillars of Relationship:**

- India and France **share long-standing cultural, trade and economic linkages**. The India-France strategic **partnership, signed in 1998**, has gathered significant momentum over time and has today evolved into an even closer multifaceted relationship that spans diverse areas of cooperation.
- Both countries **have held on to three pillars in the relationship:**
  - Mutual respect for **non-interference in internal matters**.
  - A firm commitment to **strategic autonomy and non-alignment**.
  - A shared stance of **refraining from involving each other** in respective coalitions and alliances.

- **Defence Partnerships:**
  - At the core of the **Indo-French relationship** is the **defence partnership**; France comes across as a far more willing and generous partner when compared to other western countries.
  - Starting with the **Rafale deal** to the acquisition of 26 Marine versions of Aircraft, the French have been willing to give the Indians some of their best defence systems.
  - The technology transfers by France have already helped India construct **six Scorpene-class submarines** with another three now being procured to boost the navy's falling numbers.
    - **Joint Exercises:** [Exercise Shakti \(Army\)](#), [Exercise Varuna \(Navy\)](#), [Exercise Garuda \(Air Force\)](#).
- **Similarity in Stand on NATO+ (Plus):**
  - France announced publicly that it disapproves of a **North Atlantic Treaty Organisation (NATO)-plus (NATO+)** partnership plans, that would see the Trans-Atlantic alliance build direct ties with Japan, Australia, New Zealand, South Korea and even India.
  - India has also rejected the plan saying that NATO "is not a template that applies to India".
- **Economic Cooperation:**
  - Bilateral trade between the two countries reached a new **peak at USD 13.4 billion in 2022-23**, with exports from India crossing USD 7 billion.
  - France is the 11th largest foreign investor in India, with a cumulative investment of USD 10.49 billion from April 2000 to December 2022.
- **Cooperation at International Forum:**
  - France supports India's bid for permanent membership of the **United Nations Security Council** as well as its entry into the **Nuclear Suppliers Group**.
- **Climate Cooperation:**
  - Both countries are concerned about climate change, and India has supported France in the **Paris Agreement** expressing its strong commitment to mitigating the effects of climate change.
  - Both countries, as part of their joint efforts on climate change, launched the **International Solar Alliance** in 2015.

## What are the Challenges Between India-France Relations?

- **FTA and BTIA Stagnation:**
  - The absence of an **FTA (Free Trade Agreement) between** France and India hinders the maximisation of their trade potential.
  - Additionally, the slow progress on the **India-EU Broad-Based Trade and Investment Agreement (BTIA)** further compounds the challenges in fostering comprehensive economic cooperation.
- **Differing Defense and Security Priorities:**
  - Despite a strong defense partnership, differences in priorities and approaches can influence defence and security cooperation.
    - India's regional focus and its "non-aligned" policy may at times clash with France's global interests.
- **Intellectual Property Rights Concerns:**
  - France has raised concerns **about India's inadequate protection of intellectual property rights**, impacting French businesses operating within India. This presents a challenge to fostering a conducive environment for bilateral trade.
- **Trade Imbalance and Dominance of Defense Products:**
  - Although France is India's 11th trade partner, there is a notable trade imbalance.
  - The dominance of defence products in the trade relationship **poses challenges for diversification and achieving a more balanced** economic exchange.
- **Barriers to Indian Products in France:**
  - India has faced challenges in exporting its products to France, particularly in the context of **Sanitary and Phytosanitary (SPS) measures**. This can act as a discouragement to Indian products entering the French market.
- **Student Mobility:**
  - While the French President announced plans to **welcome 30,000 Indian students to France**, issues related to student mobility, including visa processes and cultural

integration, may pose challenges to realising this goal.

▪ **Human Trafficking Concerns:**

- **Instances such as the Nicaragua flight case** involving [human trafficking raise](#) concerns and underscore the need for enhanced cooperation in addressing transnational crimes and ensuring the safety and well-being of individuals.

## Way Forward

- India and France **both can support each other** in shaping international order or even to balance out other nations on which one of them is heavily dependent.
- The Indo-Pacific concept **has provided a useful frame for the thriving Franco-Indian relations**. France, more than the [Quad partners](#), has a direct interest in the stability of the Indian Ocean owing to its overseas territories and military bases in the Indian Ocean.
- The Indo-Pacific forum between the two should be able to better assist in ensuring strategic interests and bilateral cooperation.
- France plays a critical role in India's ambitious plans to expand domestic weapon production with increased private and foreign investment.
- Discussions should encompass emerging areas of collaboration, including connectivity, climate change, cyber-security, and science and technology.

## UPSC Civil Services Examination, Previous Year Questions (PYQs)

### Prelims:

#### Q. Consider the following statements: (2016)

1. The International Solar Alliance was launched at the United Nations Climate Change Conference in 2015.
2. The Alliance includes all the member countries of the United Nations.

#### Which of the statements given above is/are correct?

- (a) 1 only
- (b) 2 only
- (c) Both 1 and 2
- (d) Neither 1 nor 2

Ans: (a)

### Mains:

#### Q. How will the I2U2 (India, Israel, UAE and USA) grouping transform India's position in global politics? (2022)

## Mosquitofish

**For Prelims:** [Mosquitofish](#), *Gambusia affinis*, *Gambusia holbrooki*, [Mosquito-borne diseases](#), [Invasive alien species](#), genetically modified OX5034 mosquito, [National Vector Borne Disease Control Programme](#).

**For Mains:** Negative Impacts of Mosquitofish, Major Challenges Related to Mosquito and Related Disease

[Source: TH](#)

## Why in News?

Recently, various regions in **Andhra Pradesh, Odisha, and Punjab** have witnessed the release of [mosquitofish into local water bodies](#) as a measure to combat the increasing mosquito menace.

- However, a recent study highlights unexpected issues with this approach, bringing attention to potential drawbacks in the biological control method.

## What is the Mosquitofish Approach and its Related Consequences?

- **Background- Rise of Mosquito-borne Diseases:**
  - Global climate and habitat changes in the last century have heightened the prevalence of [mosquito-borne diseases](#), impacting over **500 million people in 150+ countries**.
  - In India, approximately **40 million individuals** annually suffer from these diseases, posing a persistent public health challenge for decades.
- **The Mosquitofish Approach:**
  - **Mosquitofish**, native to fresh waters of the southeastern **United States**, are known for their **appetite for mosquito larvae**.
    - They can consume up to **250 larvae per day**, making them a potential weapon against mosquito populations.
  - Two species of mosquitofish, **Gambusia affinis and Gambusia holbrooki**, were considered environmentally friendly and sustainable.
    - Yet, the unintended result was the worldwide dissemination of these fish from the U.S., causing ecological disturbances.
- **Introduction of Mosquitofish in India:**
  - **Gambusia** was first introduced in India in **1928 during British rule**, as a way to combat rapid mosquito spread.
  - Subsequently, government bodies and private organizations in India collectively joined efforts to combat malaria through this method.
    - The initial idea was for the fish to control mosquito larvae, but the strategy backfired, resulting in their transformation into **invasive alien species**.
- **Negative Impacts of Mosquitofish:**
  - **Invasive Nature:** Their adaptability and high tolerance to fluctuating environmental conditions contribute to their **extensive dispersion**, making them highly invasive.
    - Mosquitofish are now considered among the hundred **most detrimental invasive alien species**.
  - **Disruption of Native Fish Communities:** They are aggressive feeders, **consuming not only mosquito larvae but also eggs of native fish species**.
    - This can lead to the extinction of local species, particularly smaller, less competitive fishes.
  - **Loss of Unique Species:** Their introduction can threaten the existence of endemic and ecologically important fish species, potentially leading to a **loss of biodiversity and ecosystem resilience**.
    - Reports indicate a decline in **Microhyla tadpoles (rice frogs or narrow-mouthed frogs)** following the introduction of Gambusia in India.
- **Related Significant Steps:**
  - The [World Health Organization](#) **stopped recommending Gambusia as a mosquito control agent in 1982**.
  - In 2018, the **National Biodiversity Authority** of the Government of India designated **G. affinis and G. holbrooki** as invasive alien species.

## Genetic Engineering Methods for Mosquito Control

- **Gene Drive Technology**, pioneered by **Austin Burt in 2003**, aims to control mosquito populations by altering their inheritance of specific genes.
  - This technique employs **proteins to modify mosquito DNA**, disrupting their ability to spread diseases like malaria.
- The **genetically modified OX5034 mosquito**, authorized by the **US Environmental Protection Agency**, was released in 2020. It is developed with a gene sensitive to an antibiotic, **tetracycline**.
  - It **carries a self-limiting gene that prevents female offspring from surviving**, leading to a reduction in mosquito populations.

## What are the Major Challenges Related to Mosquito and Related Disease Control?

- **Challenges in Mosquito Control:**
  - **Complex Environment:** Diverse **climates, geography, and socio-economic conditions** across India lead to varied breeding patterns of mosquitos.
  - **Insecticide Resistance:** Mosquitoes have developed resistance to commonly used insecticides and repellents, necessitating frequent rotation and development of new alternatives.
  - **Poor Sanitation:** Open drains, uncollected garbage, and stagnant water sources in urban and rural areas in India provide abundant breeding grounds.
- **Challenges in Disease Control:**
  - **Underreporting:** Many cases of mosquito-borne diseases, **especially in rural areas**, go unreported or misdiagnosed, hindering accurate data and targeted interventions.
    - Also, limited access to proper healthcare in remote areas delays treatment and increases complications.
  - **Vaccine Limitations:** Currently, no effective vaccines exist for all mosquito-borne diseases, making prevention mainly reliant on vector control and personal protection measures.

## Way Forward

- **Improved Sanitation and Infrastructure:** Efficient waste collection and disposal can eliminate breeding grounds in urban areas.
  - Proper drainage systems can **prevent stagnant water accumulation**, a major breeding source for mosquitoes.
  - Providing communities with **clean water storage** solutions can reduce dependence on open containers, which attract mosquitoes.
- **Integrated Vector Management (IVM):** Implement a comprehensive approach that combines various strategies such as **biological control, insecticide use, and environmental management** to address mosquito-related challenges by accelerating the implementation of the **National Vector Borne Disease Control Programme**.
- **Community Engagement and Education:** Foster public awareness and involvement in mosquito control through **educational campaigns**, emphasizing preventive measures, and encouraging community participation.

## UPSC Civil Services Examination, Previous Year Question

### Q. Consider the following statements: (2017)

1. In tropical regions, Zika virus disease is transmitted by the same mosquito that transmits dengue.
2. Sexual transmission of Zika virus disease is possible.

**Which of the statements given above is/are correct?**

- (a) 1 only
- (b) 2 only
- (c) Both 1 and 2
- (d) Neither 1 nor 2

**Ans: (c)**

**Q. 'Wolbachia method' is sometimes talked about with reference to which one of the following? (2023)**

- (a) Controlling the viral diseases spread by mosquitoes
- (b) Converting crop residues into packing material
- (c) Producing biodegradable plastics
- (d) Producing biochar from thermo-chemical conversion of biomass

**Ans: (a)**

**Mains:**

**Q. Identify the Millennium Development Goals (MDGs) that are related to health. Discuss the success of the actions taken by the Government for achieving the same. (2013)**

**Q. What do you understand by nanotechnology and how is it helping in health sector? (2020)**

## **FPI Disclosure Norms**

**For Prelims:** [Securities and Exchange Board of India \(SEBI\)](#), [Foreign portfolio investors \(FPIs\)](#), [Assets Under Management \(AUM\)](#).

**For Mains:** FPI Disclosure Norms, Indian Economy and issues relating to planning, mobilization of resources, growth, development and employment.

**Source: IE**

### **Why in News?**

Recently, the [Securities and Exchange Board of India \(SEBI\)](#) has extended more months to provide additional disclosures by the [Foreign portfolio investors \(FPIs\)](#).

- In May 2023, SEBI estimated that **FPI [Assets Under Management \(AUM\)](#)** of around Rs 2.6 lakh crore **may potentially be identified as High-Risk FPIs** requiring additional disclosures based on data as of 31st March 2023.
- **High-risk FPI** that own more than 50% or more of their equity (AUM) in a single corporate entity.

### **What are SEBI's FPI Disclosure Norms?**

- **Requirement for Additional Disclosures:**



- FPIs holding **more than 50%** of their Indian equity [Assets Under Management \(AUM\)](#) in a single Indian corporate group or holding over Rs 25,000 crore of equity AUM in the Indian markets are **required to provide additional details**.
- **Timeline for Compliance:**
  - Existing FPIs that are in breach of the investment limits as of October 2023, are required to bring down their exposure **within 90 calendar days** unless **they fall under any exempted categories**.
  - If FPIs do not meet the January-end deadline for disclosing data about their investors, they will reportedly get an additional seven months to liquidate their holdings.
    - **Liquidation of holding refers to the act of exiting a securities position, usually by selling the position for cash.** For example, an investor can decide to sell some or all of the shares held for cash in their portfolio.
- **Exempted Categories:**
  - Certain categories of FPIs are exempted from making additional disclosures.
    - These include [Sovereign Wealth Funds \(SWFs\)](#), listed companies on certain global exchanges, public retail funds, and other regulated pooled investment vehicles with diversified global holdings.

## Why has SEBI Asked FPIs to Provide Additional Disclosures?

- **Risk of Market Disruption:** SEBI is concerned that FPIs with concentrated equity portfolios in a single investee company or corporate group may **pose a risk to the orderly functioning of Indian securities markets**.
  - There is a worry that such entities, especially those with significant holdings, could potentially disrupt the market by misusing the FPI route.
- **Potential Regulatory Circumvention:** The regulator is wary of the possibility that promoters of investee companies or other investors acting in concert might use the FPI route to circumvent regulatory requirements.
  - This includes **avoiding disclosures mandated by the Substantial Acquisition of Shares and Takeovers Regulations, 2011 (SAST Regulations)** or failing to meet the [Minimum Public Shareholding \(MPS\)](#) requirements in the listed company.
- **Alignment with Regulatory Objectives:** SEBI aims to ensure the integrity, transparency, and stability of the Indian securities markets.
  - By obtaining detailed information from FPIs, the regulator seeks to align FPI activities with regulatory objectives, preventing misuse and maintaining market integrity.
- **PN3 Exclusion:** While Press Note 3 (PN3) issued by the Union government in April 2020 does not specifically apply to FPI investments, SEBI is still concerned about the **potential misuse of the FPI route**.
  - SEBI believes that obtaining additional disclosures from FPIs is **necessary to address these concerns** and protect the interests of the Indian securities markets.

## What is Press Note 3?

- During the [Covid-19 pandemic](#), the Union government amended the [Foreign Direct Investment \(FDI\)](#) policy through a Press Note 3 (2020).
  - The amendments were said to have been made **to check opportunistic takeovers/acquisitions of stressed Indian companies at a cheaper valuation**.
- The new regulations required an entity of a **country, sharing a land border with India** or where the beneficial owner of an investment into India is situated or is a citizen of any such country, **to invest only under the Government route**.
  - There are **two routes of investment for foreign investors**, the Government Route and the Automatic Route.
  - The **government route refers to obtaining official approval** from regulatory bodies for foreign investments, whereas the **Automatic Route allows investments without prior approval**, common in sectors where foreign participation is encouraged.
- Also, **in the event of the transfer of ownership of any existing or future FDI** in an entity in India, directly or indirectly, resulting in the beneficial ownership falling within the restriction/purview of the said policy amendment, such subsequent change in beneficial ownership will also require government approval.

- Press Note 3 (2020) was **enforced through Foreign Exchange Management (Non-Debt Instruments) Amendment Rules 2020**.
  - Press Note 3 is still enforceable as of January 2024.

## What are Foreign Portfolio Investors?

- Foreign portfolio investment (FPI) consists of securities and other financial assets passively held by foreign investors. It does not provide the investor with direct ownership of financial assets and is relatively liquid depending on the volatility of the market.
  - Examples of FPIs include stocks, [bonds](#), [mutual funds](#), [exchange-traded funds](#), [American Depositary Receipts \(ADRs\)](#), and [Global Depositary Receipts \(GDRs\)](#).
- **FPI is part of a country's capital account and is shown on its Balance of Payments (BOP)**.
  - The BOP measures the amount of money flowing from one country to other countries over one monetary year.
- The [Securities and Exchange Board of India \(SEBI\)](#) brought new FPI Regulations, 2019, replacing the erstwhile FPI Regulations of 2014.
- **FPI is often referred to as “hot money”** because of its tendency to flee at the first signs of trouble in an economy. **FPI is more liquid, volatile and therefore riskier than FDI.**

# FDI and FPI



### Foreign Direct Investment (FDI)

- **About:**
  - Investment made by foreign entities/individuals in **businesses and assets** located in a different country
- **FDI Routes:**
  - **Automatic Route:**
    - ◆ No prior government approval required
    - ◆ Up to 100% allowed in non-critical sectors
  - **Government Approval:**
    - ◆ Necessary in certain sectors or for investments above specific thresholds
    - ◆ Administered by **Department for Promotion of Industry and Internal Trade (DPIIT)** and RBI
- **Examples of Approval via Auto and Govt Route:**
  - Banking (Private sector): up to 49% (auto) + above 49% and up to 74% (Govt)
  - Defence: up to 74% (auto) + above 74% (Govt)
  - Healthcare (Brownfield): up to 74% (auto) + above 74% (Govt)
  - Telecom Services: up to 49% (auto) + above 49% (Govt)
- **Foreign Investment Promotion Board (FIPB):**
  - Comes under Ministry of Finance
  - Responsible for processing FDI proposals – facilitated by **Foreign Investment Facilitation Portal (FIFP)**
  - Making recommendations for Government approval

Govt's prior approval is mandatory for FDI's from countries sharing land border with India (China, Bangladesh, Pakistan, Bhutan, Nepal, Myanmar and Afghanistan)

- **India's Top 5 FDI Sources (FY 2022-23):**
  - Mauritius
  - Singapore
  - USA
  - Netherland
  - Japan
- **India's Top Sectors Attracting FDI (FY 2022-23):**
  - Services Sector
  - Computer Software & Hardware
  - Trading
  - Telecommunications
  - Automobile Industry

### Foreign Portfolio Investment (FPI)

- **About:**
  - Investments made by foreign individuals, institutions, or funds in financial assets
  - Known as Fly by Night or Hot Money
- **Imp Features:**
  - **Purchase of financial assets** occur without gaining ownership
  - Passive investment approach
  - Investors earn returns through **dividends, interest, and capital appreciation**
- **Example:**
  - Stocks, Bonds etc.
- **Regulatory Body:**
  - Securities and Exchange Board of India (SEBI)

Difference between FDI and FPI		
Features	FDI	FPI
Nature of Investment	Long-term	Short-term
Objective	Long-term presence in a foreign country	Earning quick returns on investments
Control	Significant (over the invested entity)	No or limited control
Investments in	Tangible assets (e.g., factories, buildings)	Financial assets (e.g., stocks, bonds)
Returns	Profits, Dividends, and Capital appreciation	Dividends, Interest, and Capital appreciation
Policy Regulations	Govt policies and sector-specific regulations	Flexible regulations and easier entry/exit
Impact on Economy	Job creation, technology transfer, and economic growth	Short-term liquidity and impact on stock market performance



## What are the Advantages and Concerns Related to FPI?

- **Advantages:**
  - FPI brings key advantages to India, **including increased liquidity, higher stock market valuations** and global market integration.
  - The influx of foreign capital contributes to economic growth and **competitiveness**,

particularly in technology-oriented sectors.

▪ **Concerns:**

- FPI entails risks, **with market volatility influenced** by global economic factors potentially **causing instability and currency fluctuations.**
- The **intricate nature of FPI structures presents** challenges in determining beneficial owners, **raising concerns about potential fund misuse and tax evasion.**
- **Regulatory risks, shifts in global economic conditions,** and reliance on foreign investment trends contribute to additional challenges in the FPI landscape.

## UPSC Civil Services Examination, Previous Year Questions (PYQ)

**Q. Which one of the following groups of items is included in India's foreign-exchange reserves? (2013)**

- (a) Foreign-currency assets, Special Drawing Rights (SDRs) and loans from foreign countries
- (b) Foreign-currency assets, gold holdings of the RBI and SDRs
- (c) Foreign-currency assets, loans from the World Bank and SDRs
- (d) Foreign-currency assets, gold holdings of the RBI and loans from the World Bank.

**Ans: (b)**

**Q. With reference to Foreign Direct Investment in India, which one of the following is considered its major characteristic? (2020)**

- (a) It is the investment through capital instruments essentially in a listed company.
- (b) It is a largely non-debt creating capital flow.
- (c) It is the investment which involves debt-servicing.
- (d) It is the investment made by foreign institutional investors in the Government securities.

**Ans: (b)**

- Foreign Direct Investment (FDI) is the investment through capital instruments by a person resident outside India in:
  - An unlisted Indian company; or
  - 10% or more of the post issue paid-up equity capital on a fully diluted basis of a listed Indian company.
- Thus, FDI can be in a listed or unlisted company.
- The capital invested in India via FDI is non debt creating and not allowed to serve debt.
- An investment is called Foreign Portfolio Investment, if the investment made by a person (or institutional investors) resident outside India in capital instruments is:
  - less than 10% of the post issue paid-up equity capital on a fully diluted basis of a listed Indian company, or
  - less than 10% of the paid up value of each series of capital instruments of a listed Indian company.
- Therefore, option (b) is the correct answer.

### **Mains:**

**Q.1** Justify the need for FDI for the development of the Indian economy. Why is there a gap between MoUs signed and actual FDIs? Suggest remedial steps to be taken for increasing actual FDIs in India. **(2016)**

**Q.2** Foreign Direct Investment in the defence sector is now set to be liberalised. What influence is this

## 6th Edition of Khelo India Youth Games

[Source: PIB](#)

### Why in News?

The **6<sup>th</sup> edition of Khelo India Youth Games (KIYG)** is currently underway, happening from 19th January to 31st January 2024, across four cities in Tamil Nadu: **Chennai, Trichy, Madurai, and Coimbatore.**

### What is the Khelo India Youth Games?

- **About: KIYG** is a national-level, multi-disciplinary sports competition for school and college students in India.
  - The games are held annually in January or February and are part of the government's [Khelo India initiative](#).
  - It aims to promote sports culture and identify sporting talent at the grassroots level.
  - The previous 5 editions of the Youth Games have been held in **Delhi, Pune, Guwahati, Panchkula and Bhopal.**
- **Format:** It is held in two categories, namely **under-17-year-old school students and under-21 college students.**
  - It operates in a **team championship format**, wherein the medals earned by individual athletes or teams contribute to the overall medal tally of their respective state or Union Territory (UT).
  - Upon the event's conclusion, the **state or UT securing the highest count of gold medals** is declared the winner.
  - No other team barring **Maharashtra and Haryana** have won the KIYG title to date.
- **6<sup>th</sup> edition of KIYG:** A total of 933 medals (278 gold, 278 silver and 377 bronze) are up for grabs across **26 sports at KIYG, Tamil Nadu.**
  - [Squash](#) is making its KIYG debut this year, while **Silambam**, a form of indigenous martial arts, is featured as a demonstration sport.
  - **Mascot: Veera Mangai.**
    - **Rani Velu Nachiyar, fondly called Veera Mangai**, was an Indian queen who waged a war against British colonial rule.
    - Also, the logo for the games incorporates the figure of poet [Thiruvalluvar](#).

# KHELO INDIA PROGRAMME



**AIM**

- Mass participation and promotion of excellence in sports
- Revive the sports culture in India at the grass-root level

**12 VERTICALS OF KHELO INDIA**



**GAMES UNDER KHELO INDIA**

- Khelo India Youth Games** (aka Khelo India School Games till 2019)
  - 1st edition - New Delhi (2018)
  - Age Limit - 18
  - Host of 5th Edition of KIYG - MP (Bhopal)
- Khelo India University Games**
  - 1st edition - Kalinga Institute of Industrial Technology (KIIT), Odisha (2020)
  - KIUG 2023 host - UP (Lucknow, Varanasi, G.Noida and Gorakhpur)
- Khelo India Winter Games (KIWG)**
  - 3 editions held since 2020 (in Leh, Ladakh and Gulmarg (Kashmir))

**SELECTION AND ASSISTANCE**

- 1000 kids elected yearly for a scholarship program, trained to become medal winners
- Talented players identified in priority sports disciplines are provided Rs. 5 lakh p.a. for 8 years.

**NODAL MINISTRY**

- Ministry of Youth & Sports Affairs

**HQ**

- JawaharLal Nehru Stadium (New Delhi)



## Note

The Khelo India Winter Games 2024 will take place in **Ladakh and Jammu & Kashmir**. The recently unveiled mascot, a Snow Leopard named '**Sheen-e She' or Shan**, adds a unique touch to the event.

## UPSC Civil Services Examination, Previous Year Question (PYQ)

### Prelims:

**Q. Consider the following statements in respect of the Laureus World Sports Award which was instituted in the year 2000: (2021)**

- American golfer Tiger Woods was the first winner of this award.
- The award was received mostly by 'Formula One' players so far.
- Roger Federer received this award maximum number of times compared to others.

**Which of the above statements are correct?**

- (a) 1 and 2 only  
 (b) 2 and 3 only  
 (c) 1 and 3 only  
 (d) 1, 2 and 3

**Ans: C**

- The Laureus World Sports Awards is the premier global sporting awards. First held in 2000, the annual event honours the greatest and most inspirational sporting triumphs of the year and showcases the work of Laureus Sport for Good.
- American golfer Tiger Woods was the first winner of this award.
  - Hence, statement 1 is correct.**
- The award has been received mostly by Men's Football Team (6 times) players so far.

◦ **Hence, statement 2 is not correct.**

- Roger Federer (5 times) has received this award, the maximum number of times compared to others followed by Usain Bolt (4 times) and Novak Djokovic (4 times).

◦ **Hence, statement 3 is correct.**

- **Therefore, option (c) is the correct answer.**

**Q. Consider the following statements in respect of the 32nd Summer Olympics: (2021)**

1. The official motto for this Olympics is 'A New World'.
2. Sport Climbing, Surfing, Skateboarding, Karate and Baseball are included in this Olympics.

**Which of the above statements is/are correct?**

- (a) 1 only
- (b) 2 only
- (c) Both 1 and 2
- (d) Neither 1 nor 2

**Ans: (b)**

- The Games of the 32nd Summer Olympiad (Tokyo 2020) were held from 23 July to 8 August 2021. The Olympics have been held every four years since 1948.
- However, Tokyo Olympic 2020 was not held after four years as it was postponed for 2021, because of Covid pandemic.
- The official motto for Olympics 2020 was "United by Emotion". The motto emphasised the power of sport to bring together people from diverse backgrounds of every kind and allow them to connect and celebrate in a way that reaches beyond their differences. **Hence, statement 1 is not correct.**
- A total of 46 Olympic Sports were contested at the Tokyo 2020 Games including Rugby, Sport Climbing, Fencing, Football, Skateboarding, Handball, Surfing, Karate, Baseball, among others. **Hence, statement 2 is correct.**
- **Therefore, option (b) is the correct answer.**

**Mains:**

**Q.** An athlete participates in Olympics for personal triumph and nation's glory; victors are showered with cash incentives by various agencies, on their return. Discuss the merit of state sponsored talent hunt and its cultivation as against the rationale of a reward mechanism as encouragement. **(2014)**

## **Philippines and Vietnam Cooperation in South China Sea**

Recently, the Philippines and Vietnam have made significant strides in strengthening their **cooperation in the [South China Sea](#)**, despite opposition from **China, which also claims the region.**

- The agreements between the two countries cover various aspects of their relationship, including **maritime security, trade, and investment.**
- The South China Sea is a marginal sea of the **Western Pacific Ocean**. It is bordered by Brunei Darussalam, Malaysia, Indonesia, the Philippines, Singapore, Thailand, Vietnam and China.
  - It is connected by the **Taiwan Strait with the East China Sea** and by the **Luzon Strait with the Philippine Sea** (both marginal seas of the Pacific Ocean).
  - The South China Sea is a contested maritime area that is the subject of territorial disputes between six countries: **China, Brunei, Taiwan, Vietnam, Malaysia, and the**

## Philippines.

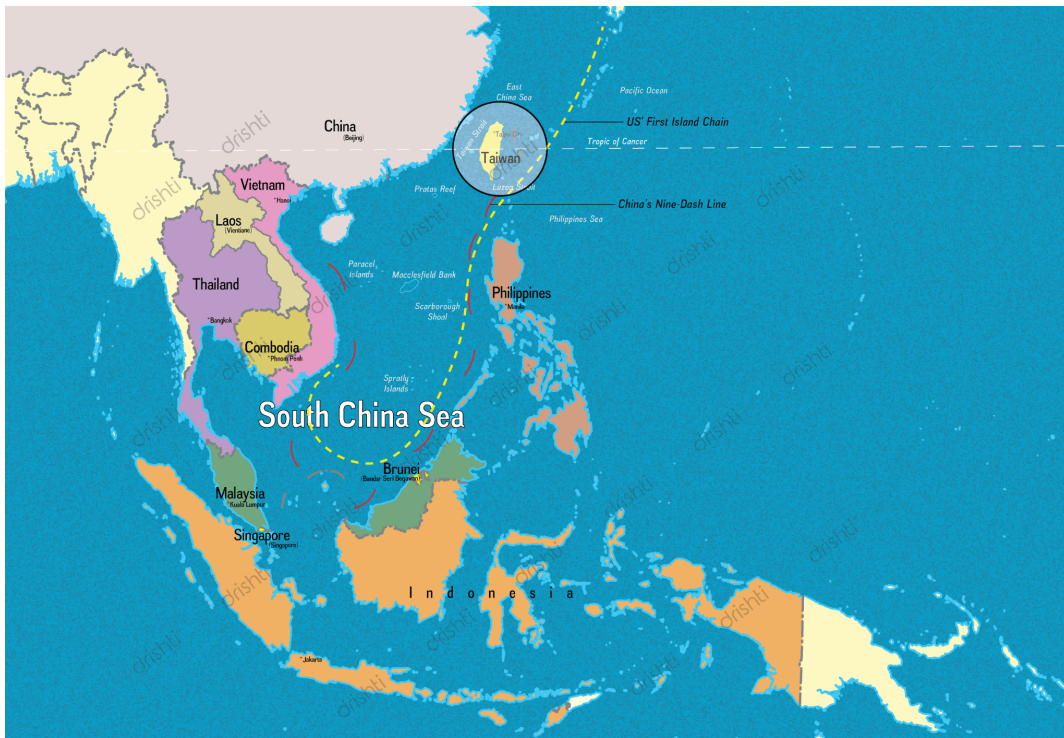

Read more: [South China Sea](#)

---

## UNRWA Funding Freeze Amid Gaza Conflict

The US and eight other Western countries, which are major contributors to the [United Nations Relief and Works Agency for Palestine Refugees in the Near East \(UNRWA's\)](#) 2022 budget, have decided to pause funding for the agency.

- UNRWA was established in **1949** to provide aid to [Palestinians](#) who were displaced during the 1948 **Arab-Israeli war**.
- It operates in [Gaza](#), **Israeli-occupied West Bank**, **Lebanon**, **Syria**, and **Jordan**, offering education, health, relief, social services, microfinance, and emergency assistance programs.
  - The agency currently serves around **5.9 million Palestinian refugees** and plays a vital role in providing essential services to Palestinians in Gaza.
- The halt of funding is the result of Israel accusing UNRWA staff of involvement in an [attack on Israel on 7<sup>th</sup> October 2023](#) and has alleged that  [Hamas](#) uses UNRWA facilities for military purposes and teaches anti-Israel sentiment in its schools.

Read more: [United Nations Relief and Works Agency for Palestine Refugees in the Near East](#)

---

## Ancient Lake on Mars

[NASA's Perseverance rover](#) has substantiated the existence of **ancient lake sediments** in [Mars'](#)

[Jezero Crater](#) through ground-penetrating radar observations.

- The findings support the theory that **Mars underwent a transition from being cold and arid to becoming warm, wet**, and possibly suitable for habitation.
- Perseverance is a car-sized Mars rover designed to explore the Jezero crater on Mars as part of **NASA's Mars 2020 mission**.
  - It was manufactured by the Jet Propulsion Laboratory and launched on **30<sup>th</sup> July 2020**.

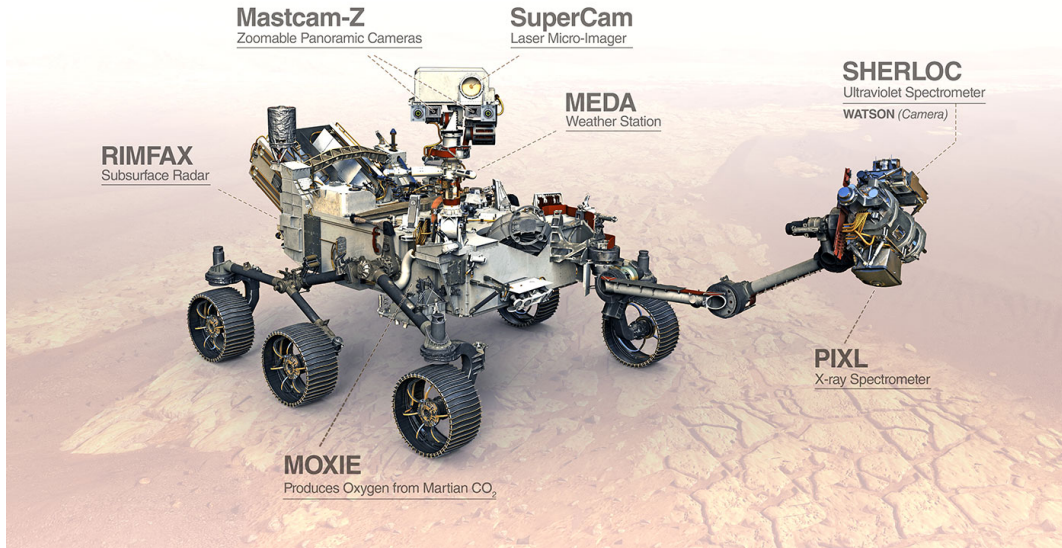

Read more: [NASA's Perseverance Rover](#)

---

## Voluntary Carbon Market Framework for Agriculture Sector

Recently, the central government initiated a framework for **voluntary carbon markets** in the **agriculture sector**, aiming to encourage small and medium farmers to benefit from carbon credits and promote eco-friendly farming practices.

- **Voluntary Carbon Market** is a trading system where individuals and organizations can voluntarily buy and sell carbon credits to offset **greenhouse gas (GHG) emissions**.
  - Each credit symbolises one metric ton of **avoided, reduced or removed CO<sub>2</sub>** or equivalent GHG.
  - These credits originate from projects that cut emissions, like tree planting, renewable energy investment etc.



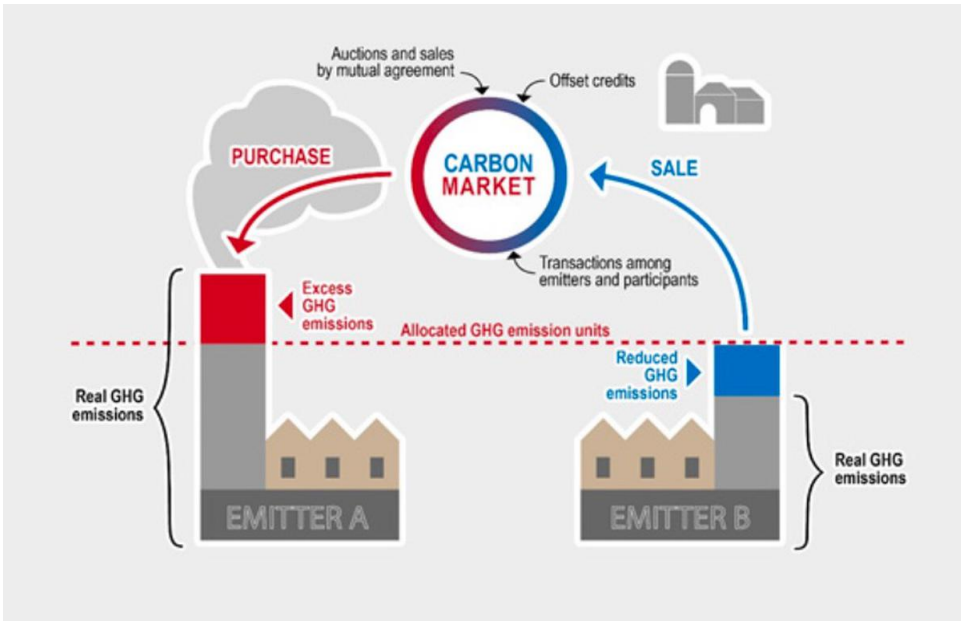

Read more: [Carbon markets](#)

PDF Reference URL: <https://www.drishtiias.com/current-affairs-news-analysis-editorials/news-analysis/31-01-2024/print>

