



drishti

**STATE
PCS CA**

CONSOLIDATION

JAMMU & KASHMIR

**OCTOBER
2024**

Drishi, 631 First Floor, Dr. Mukharjee
Nagar, Delhi-110009

Inquiry (English): 8010-440-440
Inquiry (Hindi): 8750-187-501

Website: www.drishtias.com
Email: help@groupdrishti.in

Content

● J&K Integrity Pledge	3
● Revival of Jammu & Kashmir's Darbar Move Practice.....	3
● J&K LG Calls Assembly Session	4
● Z-Morh Project in Kashmir.....	4
● Major Infrastructure Projects in J&K	5
● India-China Standoff and Patrolling Arrangements Along LAC	6
● Kashmir Hosts its First-Ever International Marathon	6
● Prevalence of Non-Communicable Diseases (NCDs) in J&K	7
● SC to Consider Plea for Restoring Jammu & Kashmir's Statehood.....	8
● Re-Exploration of J&K's Lithium Reserve.....	9
● Jammu & Kashmir Gets New CM	10
● Omar Abdullah to Take Oath as J&K CM	11
● Jamaat-e-Islami in Jammu & Kashmir.....	12
● NC and PDP: A Political Overview	12
● Nominated MLAs and Potential Impact on J&K Assembly	13
● Kashmir on the Verge of a New Era: GOC 15 Corps	14
● Jammu & Kashmir Elections 2024	15
● Impact of Candidate's Death in Elections.....	15
● Nalin Prabhat Appointed as J&K DGP.....	16



drishhti

J&K Integrity Pledge

Why in News?

Recently, J&K Chief Minister led an integrity pledge as part of **Vigilance Awareness Week** to reinforce anti-corruption efforts.

Key Points

- **Commitment to Transparency:**
 - Chief Minister emphasized a corruption-free Jammu & Kashmir through reforms, strict oversight, and citizen empowerment, aligning with the Vigilance Week theme of “**Culture of Integrity for Nation’s Prosperity.**”
- **Widespread Participation:**
 - The pledge involved ministers, secretariat officials, and district-level leaders, with additional ceremonies held across departments to ensure full administrative support for integrity in governance.
- **Mission for Ethical Governance:**
 - CM reinforced his government’s goal to prioritize public welfare, stressing a governance model that focuses on transparency, efficient resource use, and integrity-driven decision-making.

Vigilance Awareness Week

- The **Central Vigilance Commission** (CVC) observes the Week every year during the week in which the birthday of **Sardar Vallabhbhai Patel** (31st October) falls.
- **Objective:** It affirms India’s commitment to the promotion of integrity and probity in public life through citizen participation and reiterates Government’s resolve to continue the crusade against corruption.

Revival of Jammu & Kashmir’s Darbar Move Practice

Why in News?

Recently, discussions have emerged regarding the potential reintroduction of Jammu & Kashmir’s historic “**Darbar Move,**” a biannual tradition involving the

relocation of government offices between **Jammu and Srinagar.**

Key Points

- **Historical Background:**
 - The Darbar Move, a **149-year-old** practice introduced by **Maharaja Ranbir Singh in 1872**, aimed to balance the needs of **Jammu (winter capital)** and **Srinagar (summer capital)** by rotating the administrative seat every **six months.**
 - This rotation fostered economic and social integration between the two cities.
- **Abolition of the Practice:**
 - In 2021, Jammu & Kashmir’s **Lieutenant Governor** halted the Darbar Move, citing cost-cutting and the transition to digital governance.
 - The government estimated annual savings of **approximately Rs. 200 crore**, which would be reallocated to welfare projects.
 - Additionally, ending the practice facilitated a year-round digital operation of offices in both cities, leading to the **cancellation of government housing** for officials in the non-operational city.
- **Economic and Cultural Impact:**
 - The abolition of the **Darbar Move** has reportedly impacted Jammu’s economy, with the local business community experiencing reduced seasonal trade.
 - This issue has resurfaced in local elections, as stakeholders call for its revival to boost economic activity in both cities.
- **Current Developments:**
 - Political parties, particularly those aiming to strengthen local economies, have voiced their support for reinstating the Darbar Move.
 - They argue that its absence has led to uneven economic opportunities across regions. The upcoming elections might shape the decision on whether the tradition is restored, influenced by public sentiment and business needs.

Maharaja Ranbir Singh

- Ranbir Singh was Maharaja of Jammu and Kashmir from **1856 to 1885.**
- He was the third son of **Gulab Singh**, the founder of the Jammu & Kashmir state.

Note:

- **During his reign, Ranbir Singh:**
 - **Annexed Gilgit:** Ranbir Singh annexed Gilgit after a rebellion against the state.
 - **Established a judicial system:** He established a modern judicial system and compiled civil and criminal laws into the Ranbir Penal Code.
 - **Developed the silk industry:** He made the silk industry a state monopoly by setting aside 30,000 pounds sterling for its development. He also built 127 rearing houses to raise silkworms.
 - **Translated books:** He was a scholar of Sanskrit and Persian and translated many books.
 - **Helped the British:** He sent his troops to help the British besiege Delhi during the mutiny.

J&K LG Calls Assembly Session

Why in News?

The **Lieutenant Governor (LG)** of **Jammu & Kashmir**, has called for an **assembly session** on **4th November, 2024**, marking a significant legislative moment for the **Union Territory**.

Key Points

- The decision was made under **Sections 18 and 19 of the J&K Reorganisation Act, 2019**. This Act governs the functioning of **Jammu & Kashmir as a Union Territory** since its bifurcation in 2019.
- **Powers of the LG:**
 - Under **Article 239A** of the Indian Constitution, the LG of a Union Territory has the authority **to summon and address legislative assemblies**, similar to the powers vested in a Governor for states.
 - The LG is also responsible for ensuring the smooth conduct of business in the assembly, **including the election of the speaker**.
- **Procedure for Conduct of Business:**
 - The **election of the speaker** is scheduled for **4th November**, as per **Rule 19(1)** of the **J&K Reorganisation Act, 2019**, which governs the legislative assembly's conduct in Jammu & Kashmir.

- The LG will address the assembly in the opening session, outlining the administrative and policy directions of the government. This is akin to the traditional governor's address in states, setting the legislative agenda for the new assembly.

Jammu & Kashmir Reorganisation Act, 2019

- It divided Jammu and Kashmir into **2 Union Territories of Jammu & Kashmir and Ladakh**.
- It repealed **Article 370**, which had granted Jammu & Kashmir a unique status.
- Leh and Kargil districts were included in the Union Territory of Ladakh, while the remaining areas became part of Jammu and Kashmir.
- Five Lok Sabha seats were retained by Jammu and Kashmir, and one was transferred to Ladakh.
- **Legislature:** The seats in the Legislative Assembly will be reserved for **tribal and scheduled caste** people to keep the proportion intact of their population in the Union Territory of Jammu and Kashmir.
 - The **Lt. Governors** can nominate two women members for the Assembly to represent women if women are not sufficiently represented to justify equality between men and women.
 - The elected Legislative Assembly will continue for 5 years, and the Lt. or The Governor will summon the Assembly once every six months.
 - The Legislative Assembly has the right to pass a law for any given part of the Union Territory of J&K related to any of the matters listed in the Indian Constitutions State's List except for the "Police" and "Public Order."
 - Any matter specified in the Concurrent List will be applied to Indian Union Territories. Furthermore, Parliament will have the decision-making power to create laws for Jammu Kashmir and its Union Territory.

Z-Morh Project in Kashmir

Why in News?

The **Z-Morh tunnel** project in **Jammu & Kashmir** recently witnessed militant attacks highlighting strategical significance of the project.

Note:

Key Points

- **Z-Morh Tunnel:**
 - A **6.4 km-long tunnel** connecting the **Sonamarg** health resort with Kangan town, Ganderbal district.
 - Located near **Gangangir village**, the tunnel's name is derived from the **Z-shaped road** stretch where it is constructed.
 - It will provide all-weather connectivity to Sonamarg, a major tourist destination on the **Srinagar-Leh highway**.
- **Strategic Importance:**
 - The tunnel is part of the larger **Zojila Tunnel project**, aimed at ensuring all-weather connectivity between Srinagar and Ladakh.
 - It is critical for **military logistics, enabling faster movement of troops to Ladakh**, where tensions with both **Pakistan and China** exist.
 - The tunnel facilitates safe connectivity to regions like **Dras, Kargil, and Leh**, which are crucial for defense operations, particularly around the **Siachen Glacier** and **Eastern Ladakh**.
 - Z-Morh tunnel will act as a precursor to the **Zojila Tunnel**, which is under construction and expected to be completed by **December 2026**.
 - Enhances India's capability in reinforcing military personnel in sensitive areas of Ladakh, vital **post-2020 India-China standoff**.
- The attack on the project underscores evolving threats to critical infrastructure, highlighting the importance of safeguarding national projects from insurgent activities.

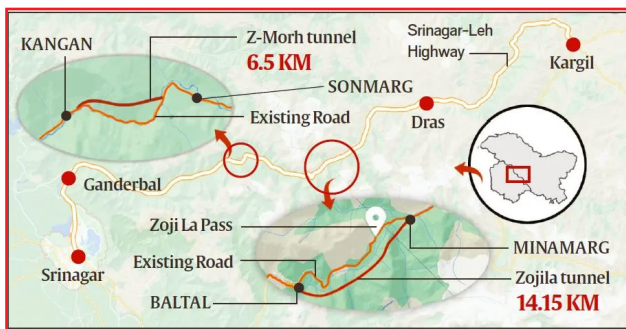

Note:

Major Infrastructure Projects in J&K

Why in News?

The recent militant attack has put a spotlight on ongoing infrastructure projects in **Jammu & Kashmir**, with contractors assessing risks but not yet raising alarm.

Key Points

- **Ongoing Mega Projects in J&K:**
 - The Centre is executing **51 mega projects in Jammu & Kashmir**, initially estimated at Rs 76,000 crore, but costs have risen by **56% to Rs 1.16 trillion**, as per the **Ministry of Statistics and Programme Implementation (MoSPI)**.
 - **Udhampur-Srinagar-Baramulla Rail Link (USBRL):**
 - It is a **Rs 42,500 crore** project and connects Kashmir Valley with India, stalled since 1995. It features the world's highest rail bridge over the **Chenab River**, crucial for regional integration, economic growth, and defense mobility.
 - **J&K Rail Link Project Dharam:**
 - The **Dharam-Banihal** section of the **Jammu & Kashmir Rail Link Project** is part of the Katra-Banihal section of the **Udhampur-Srinagar-Baramulla Rail Link (USBRL)** Project.
 - The project is a national initiative to connect the Kashmir Valley to the rest of India by rail. The Dharam-Banihal section includes a **Tunnel Communication System** that provides uninterrupted radio communication between handheld devices and base stations.
- **National Highways and Infrastructure Development Corporation Ltd. (NHIDCL):**
 - **NHIDCL** is a government-owned company established in 2014 for the development & maintenance of **National Highways & Strategic Roads of India**.
 - It operates as a nodal agency of the **Ministry of Road Transport and Highways (MoRTH)**.



PAVING THE WAY

- 51 mega infrastructure projects, initially valued at ₹76,000 crore, now cost ₹1.16 trillion
- Projects include the Udampur–Srinagar–Baramulla Rail Link, nearing completion at ₹42,500 crore
- Contractors report no significant impact on operations after recent attacks in J&K
- Major firms involved include Megha Engineering, Afcons Infrastructure, L&T, and Patel Engineering
- Local workforce involvement seen as key to mitigating security risks

Z-Morh Tunnel

- A **6.4 km-long tunnel** connecting the **Sonamarg health resort** with Kangan town, Ganderbal district.
- Located near Gagangir village, the tunnel's name is derived from the **Z-shaped road** stretch where it is constructed.
- It will provide all-weather connectivity to Sonamarg, a major tourist destination on the **Srinagar-Leh highway**.

India-China Standoff and Patrolling Arrangements Along LAC

Why in News?

India and China have been engaged in a prolonged **standoff since 2020** along the **Line of Actual Control (LAC)** in the Ladakh region, with several points of contention and military confrontations.

- Recent developments indicate efforts towards easing tensions and restructuring patrolling arrangements.

Key Points

- **Sectors Across the LAC:** It is divided into three sectors.
 - The **eastern sector** which spans Arunachal Pradesh and Sikkim (1346 km).
 - The **middle sector** in Uttarakhand and Himachal Pradesh (545 km).

- The **western sector** in Ladakh (1597 km).
- The alignment of the LAC in the eastern sector is along the **1914 McMahon Line**.
 - The McMohan line marked out previously unclaimed/undefined borders between **Britain and Tibet**. The middle sector is the least disputed sector, while the western sector witnesses the highest transgressions between the two sides.

Key Events in India-China Border Tensions



Disengagement along LAC

Patrolling arrangement
Foreign secretary Vikram Misri said India and China have arrived at an agreement on "patrolling arrangements" along the LAC, "leading to disengagement and a resolution of the issues that had arisen in these areas in 2020."

Resolving pending fissures
The breakthrough in negotiations will pave the way to solve the dragging impasse in Depsang Plains and Demchok, thus far the two remaining friction points in eastern Ladakh

How the impasse began
Standoff on the LAC began with a skirmish between Indian and Chinese troops on the banks of Pangong Lake in May 2020. A brutal clash at Galwan Valley in June 2020 killed 20 Indian soldiers and an unspecified number of Chinese troops

"We reached an agreement on patrolling. With that...we have gone back to where the situation was in 2020, and...the disengagement process with China, you can say, has been completed."
- S Jaishankar, external affairs minister

Kashmir Hosts its First-Ever International Marathon

Why in News?

Recently, Kashmir added another achievement by hosting its **first-ever international marathon in Srinagar**, attracting over 1,700 runners from **across India and 12 foreign countries**.

Note:

- The total registrations included 469 runners for the 42-km full marathon and 666 for the half marathon, with **participants from nations such as Kenya, Denmark, Norway, and the UAE.**

Key Points

- The marathon served as a platform not only for showcasing sporting prowess but also for **promoting the region's rich cultural heritage, handicrafts, and famous cuisine on a global scale.**
- The restoration of peace and harmony has played a key role in enabling the area to host major international events such as **G20 meetings, Formula-4 races, and International Yoga Day**, highlighting the region's growing capability to attract global attention and participation.
 - To showcase the potential of J&K as a destination for tourism and investment, the **government hosted the G20 Tourism Working Group** meeting in Srinagar.
 - This was the **first significant international event in J&K** to integrate the region with the rest of the country and the world.
 - The city **hosted its first-ever Formula-4 racing event**, with the aim of promoting **tourism** and providing diverse career opportunities for local youth.
 - Prime Minister **celebrated the 10th International Day of Yoga in Srinagar**, emphasising yoga's global impact on health and societal harmony.
- The government **has also hosted other business meetings in J&K** to attract investment and promote industrial development.
 - In June 2022, the government also held a **Global Investors Summit in J&K**, which witnessed participation from more than 200 domestic and foreign companies.
 - The summit **showcased various sectors and opportunities** for investment in J&K, such as agriculture, **horticulture**, handicrafts, tourism, IT, **renewable energy**, etc.
- These events have **demonstrated the government's commitment to boost the economy and livelihood of J&K.** They have also helped to change the global perception of J&K as a conflict-ridden region and highlight its potential as a peaceful and prosperous destination.

Prevalence of Non-Communicable Diseases (NCDs) in J&K

Why in News?

Recently, the Union Minister Dr. Jitendra Singh, who is also a nationally renowned Diabetologist, today released the Jammu related data of the **'first of its kind' world's largest survey 'ICMR-India Diabetes 'INDIAB' Study** to assess the prevalence of **Diabetes** in India.

Key Points

Key Highlights from the ICMR-INDIAB Study:

- **Survey Scope and Methodology:**
 - The Jammu phase of the ICMR-INDIAB study included 1,520 participants from **both urban and rural areas**, providing critical insights into the region's health landscape.
 - The **survey was conducted by the Madras Diabetes Research Foundation** in collaboration with the **Indian Council of Medical Research (ICMR)** and the Department of Health Research.
- **Diabetes Prevalence in Jammu Region:**
 - The study reveals that the overall prevalence of diabetes in the Jammu region, covering 10 districts, is **18.9%**.
 - Urban areas show a **higher prevalence at 26.5%**, while rural areas report a rate of 14.5%, both surpassing the national average.
 - Additionally, **10.8% of the population in the region is affected by prediabetes**, indicating a significant risk of developing diabetes in the future.
- **Other Health Indicators:**
 - The survey found the **prevalence of hypertension to be 27.1%**.
 - Generalised **obesity** affects 41.7% of the population, while 62.7% suffer from abdominal obesity, which is a known risk factor for diabetes.
- **Significance of the Study:**
 - The findings are expected to guide policymakers, health professionals, and stakeholders in developing targeted interventions for the prevention and management of diabetes and **Non-Communicable Diseases (NCDs)** in Jammu, as well as across India.

Note:

- **Focus on Early Detection and Maternal Health:**
 - There is a need for early detection of diabetes to control the spread and recommended measures to prevent the intergenerational transmission of the disease, **particularly through managing diabetes in pregnant women.**
 - The need for a multi-sectoral approach involving government agencies, **non-governmental organizations**, the community, and individuals to curb the rising cases of diabetes and other NCDs was also emphasised while highlighting the findings
- **Health and Wellness Centres Initiative:**
 - The government is setting up nearly **1.5 lakh Health and Wellness Centres across India**, focusing on the prevention and control of NCDs like diabetes, hypertension, and certain types of cancer.

Diabetes

- Diabetes or **Diabetes Mellitus (DM)** is a medical disorder characterised by **insufficient insulin production or an abnormal response to insulin**, leading to elevated blood sugar (glucose) levels.
- While **70–110 mg/dL fasting blood glucose is considered normal**, blood glucose levels between 100 and 125 mg/dL is considered prediabetes, and 126 mg/dL or higher is defined as diabetes.
- **Initiatives to Tackle Diabetes:**
 - National Programme for Prevention and Control of Cancer, Diabetes, Cardiovascular Diseases and Stroke (NPCDCS).
 - [World Diabetes Day](#)
 - [Global Diabetes Compact](#)

Types of Diabetes

	Type 1 Diabetes	Type 2 Diabetes
Causes	In this, the pancreas does not make insulin, because the body's immune system attacks the islet cells in the pancreas that make insulin.	In this, the pancreas makes less insulin and the body becomes resistant to insulin

Prevalence	Type 1 diabetes affects about 5-10% of people with diabetes, typically developing before age 30, though it can occur later in life.	Type 2 diabetes is more common but typically begins after age 30 and increases with age
Prevention	Cannot be prevented.	Can be prevented with lifestyle changes.

SC to Consider Plea for Restoring Jammu & Kashmir's Statehood

Why in News?

Recently, the **Supreme Court** agreed to hear a petition regarding the **restoration of Jammu & Kashmir's statehood**, following the 2019 bifurcation.

Key Points

- The bifurcation occurred after the **abrogation of Article 370** in 2019, which led to the formation of two **Union Territories (J&K and Ladakh)**.
- **Article 3 of the Constitution:** Formation of New States
 - **Parliament** holds the power to enact legislation for the formation of new States.
 - **New States can be created by:**
 - Separating territory from an existing State.
 - Uniting two or more States.
 - Uniting parts of different States.
 - Uniting any territory to a part of any State.
 - **Parliament also has the authority to:**
 - Increase or diminish the area of any State.
 - Alter the boundaries or name of any State.
 - Here, the word State includes a Union Territory also.
- **Checks on Parliament's Power:**
 - A bill for the formation of new States can only be introduced in either **House of Parliament** upon the recommendation of the **President**.
 - If the bill affects the areas, boundaries, or name of a State, the President must refer the bill to the concerned State Legislature for its views.

Note:

- The views of the **State Legislature** must be communicated to Parliament, but Parliament is not bound by them.
- **State Legislature's Role:**
 - The State Legislature's only role is to express its views when requested by the President.
 - Parliament is not obligated to adhere to the views of the **State Legislature** when forming new States.
- Laws enacted under **Article 3** are not considered amendments to the Constitution, even if they modify provisions of the **First Schedule** (list of States and **Union Territories**) or the **Fourth Schedule** (allocation of seats in the **Rajya Sabha**).
 - This means such laws can be passed by a **simple majority in Parliament**, not requiring the special procedure for constitutional amendments.

Re-Exploration of J&K's Lithium Reserve

Why in News?

Recently, the **5.9 million tonnes of lithium reserves in Jammu & Kashmir (J&K)** are set for re-exploration after failed attempts to auction the reserve due to insufficient exploration data and industry reluctance.

- This move aims to boost **India's domestic lithium production**, which is critical for energy transitions and reducing dependence on imports.

Key Points

- **Current Status of the Reserve:**
 - The Salal-Haimana block in the Reasi district of J&K holds an estimated **5.9 million tonnes of lithium reserves**. It is India's largest lithium find, announced in February 2023.
 - The **Salal-Haimana block** also contains **titanium and bauxite**, which may have additional extraction potential.
 - However, the block is still at the **G3 level of exploration**, which involves preliminary prospecting and mapping
- **Re-Exploration to G2 Level:**
 - The Ministry of Mines has directed the **Geological Survey of India (GSI)** to elevate the exploration to at least the **G2 level**.

- This involves more detailed surveys and geological studies, which provide better data on the commercial viability of the reserves. **Achieving G2 means clearer reserve estimates and improved resource confidence.**
- **G2 exploration** is more detailed compared to G3. It includes drilling and trenching to estimate the size, grade, and shape of the mineral deposit. **Further exploration to G1 (the final stage) is necessary for a more precise assessment before mining**
- **Lithium Ores and Extraction:**
 - **Lithium** is extracted primarily from **spodumene** (a lithium-bearing mineral found in pegmatites) or from **brine pools where lithium salts** are concentrated. In places like **Chile and Argentina**, **lithium is mainly extracted from brines**, while in **Australia**, it is mined from **spodumene**
- **Challenges Faced in Auctioning:**
 - The first auction attempt in November 2023 failed due to a lack of sufficient bidders. The second attempt, which allowed for a single bidder, also saw no success. The key issue is **inadequate exploration data**, which makes potential bidders reluctant to commit.
 - Experts caution that detailed exploration should not be rushed, as premature auctioning without solid resource estimates might deter future interest
- **India's Lithium Import Dependency:**
 - India currently imports all its lithium, with lithium-ion battery imports reaching **USD 2.9 billion in 2023-24**, primarily from **China and Hong Kong**. This underscores the importance of developing domestic lithium resources
 - The discovery of lithium in J&K is seen as pivotal for reducing import dependence, particularly as India pushes for electric vehicle (EV) adoption
- **Global Lithium Reserves and India's Efforts:**
 - Globally, **98 million tonnes of lithium** resources exist, but only **26 million tonnes** are considered reserves. Countries like **Chile, Australia, and Argentina** dominate the market. India has partnered with Argentina for lithium exploration and is exploring opportunities in **Chile, Bolivia, and Australia**

Note:



Properties of Lithium

- It is a chemical element with the **symbol Li**.
- It is a soft, **silvery-white metal**.
- Under standard conditions, it is the lightest metal and the lightest solid element.
- It is highly **reactive and flammable**, and must be stored in mineral oil.
- It is an alkali metal and a rare metal.
 - The alkali metals consist of the chemical elements lithium, sodium, potassium, rubidium, caesium, and francium. Together with hydrogen they constitute group, which lies in the s-block of the periodic table.
 - Rare Metals (RM) include **Niobium (Nb), Tantalum (Ta), Lithium (Li), Beryllium (Be), Cesium (Cs) etc.** and **Rare Earths (RE) include Lanthanum (La) to Lutetium (Lu) besides Scandium (Sc) and Yttrium (Y)**.
 - These metals are strategic in nature with wide application in the nuclear and other high tech industries such as **electronics, telecommunication, information technology, space, defense etc.**

Jammu & Kashmir Gets New CM

Why in News?

Recently, Omar Abdullah was sworn in as the **Chief Minister** of **Jammu & Kashmir**, focusing on restoring

regional balance between Jammu & Kashmir through his new cabinet.

Key Points

- **Cabinet Composition:**
 - The new cabinet includes a blend of leaders from Jammu & Kashmir, such as **Surinder Kumar Choudhary, a prominent leader from Jammu, as Deputy Chief Minister, and Javed Rana and Satish Sharma from Jammu.**
 - The inclusion of Surinder Kumar Choudhary and other Jammu leaders signifies Abdullah's attempt to address the polarized electorate post the abrogation of **Article 370**, which removed J&K's special status.
- **Role of Governor and Constitutional Provisions:**
 - Under **Article 164**, the Governor appoints the Chief Minister, who is typically the leader of the majority party, and the Council of Ministers is appointed on the advice of the Chief Minister.
 - **Article 163** grants the Governor discretionary powers in special situations, especially in appointing the CM and dealing with coalition politics.
- The demand for **restoration of statehood** remains central, as leaders continue to push for its reinstatement.

Chief Minister

- **Appointment:**
 - Article 164 of the Constitution envisages that the Chief Minister shall be appointed by the **governor**.
 - A leader of the party that has got the majority share of votes in the assembly elections, is appointed as the Chief Minister of the state.
 - The Governor is the nominal executive authority, but real executive authority rests with the Chief Minister.
 - However, the discretionary powers enjoyed by the governor reduces to some extent the power, authority, influence, prestige and role of the Chief Minister in the state administration.
 - A person who is not a member of the state legislature can be appointed as Chief Minister for six months, within which time, he should be elected to the state legislature, failing which he ceases to be the Chief Minister.

Note:

➤ Term of the CM:

- The term of the Chief Minister is not fixed and he holds office during the pleasure of the governor.
 - He cannot be dismissed by the governor as long as he enjoys the majority support in the legislative assembly.
- The State Legislative Assembly can also remove him by passing a vote of **no-confidence** against him.

➤ Powers and Functions:

- **With Respect to Council of Ministers:**
 - The governor appoints only those persons as ministers who are recommended by the Chief Minister.
 - He allocates and reshuffles the portfolios among ministers.
 - He can bring about the collapse of the **council of ministers** by resigning from office, since the Chief Minister is the head of the council of ministers

Omar Abdullah to Take Oath as J&K CM

Why in News?

Recently, elections were concluded in the **Union Territory of Jammu & Kashmir**, and a new **Chief Minister** is to be appointed along with the revocation of **President's Rule**.

Key Points

➤ President's Rule Revoked:

- Following the election results, **President's Rule** was revoked in J&K.
- The revocation process involves the President issuing a proclamation based on a report from the **Governor or Lieutenant Governor (LG)**, citing that conditions for forming a government are favorable after elections.
- **President's Rule:**
 - **Article 356** of the Indian Constitution allows the President to impose direct **governance (President's Rule)** in a state when the state

government is unable to function as per constitutional provisions.

➤ Governor's Role (Now LG):

- Under **Article 164**, the **LG (previously Governor)** plays a key role in inviting the leader of the majority party or coalition to form the government.
- The LG ensures the formation of a government that enjoys majority support in the legislature.

➤ Oath of Office:

- As per **Article 164(3)**, the CM and other ministers are administered the **oath of office by the Governor (or LG in Union Territories)**.
- The oath signifies allegiance to the Constitution and the discharge of duties in accordance with the law.

➤ Legislative Assembly's Role:

- The newly formed **Legislative Assembly in J&K**, reinstated post-elections, will have the authority to enact laws, approve budgets, and represent the people of the **Union Territory**.
- The CM will head the executive arm of the government, accountable to the **Legislative Assembly**.

PRESIDENT'S RULE

WHAT IT MEANS

HOW CAN IT BE IMPOSED IN A STATE

- 1 On recommendation of Governor in case of failure of constitutional machinery
- 2 If a state legislature is unable to function according to constitutional provisions

Article 356 of the Indian Constitution has the provision of President's Rule



EXECUTIVE AUTHORITY
Exercised through the centrally appointed Governor



PARLIAMENT'S ROLE
Every such proclamation must get Parliament's approval within two months from date of issue

DURATION 
6 months
A maximum of 3 years by approval of Parliament after every 6 months

TERMINATION 
By President, any time (s)he deems fit; does not need Parliament's approval

A NEW PROVISION
The 44th Constitutional Amendment 1978 states that the President's Rule can't be imposed in any state beyond 1 year unless

- 1 A Proclamation of National Emergency is in operation
- 2 The Election Commission certifies that the continuance of President Rule is necessary to hold Assembly elections



Note:

Jamaat-e-Islami in Jammu & Kashmir

Why in News?

In the latest Jammu & Kashmir polls, the **Jamaat-e-Islami**, re-entering electoral politics after nearly four decades, performed poorly, with eight out of ten candidates losing their deposits.

Key Points

➤ Background on Jamaat-e-Islami (Jel):

- Emerged from Islamic reformist movements in late 19th century Kashmir **under Dogra rule**.
- It aimed to eliminate un-Islamic practices and promote modern and Islamic education.
- The group, originally supporting Kashmir's integration with Pakistan, became politically active after the Partition.
- This religious-political organisation was banned by the Ministry of Home Affairs (MHA) in 2019 under the **Unlawful Activities (Prevention) Act (UAPA), 1967**.
- Historically maintained a **boycott** of the electoral process but recently changed stance, participating in Parliamentary elections.

Unlawful Activities (Prevention) Act (UAPA), 1967

➤ Background:

- On 17th June 1966, the President promulgated the Unlawful Activities (Prevention) Ordinance "to provide for the more effective prevention of unlawful activities of individuals and associations".
 - Subsequently, the **Unlawful Activities (Prevention) Act, 1967** was enacted.

➤ About:

- The Unlawful Activities (Prevention) Act, 1967 was enacted to provide for more effective prevention of certain unlawful activities of individuals and associations, for dealing with terrorist activities, and for matters connected therewith.
 - Unlawful activities are defined as actions supporting or inciting the cession or secession of any part of India, or actions questioning or disrespecting its sovereignty and territorial integrity.

- The **National Investigation Agency (NIA)** is empowered by the UAPA to investigate and prosecute cases nationwide.
 - The Act also empowers the Director-General, the National Investigation Agency (NIA) to grant approval of the seizure or attachment of property when the case is being investigated by the agency.

➤ Amendments:

- It underwent multiple amendments (2004, 2008, 2012 and 2019) expanding provisions related to terrorist financing, **cyber-terrorism**, individual designation as terrorist, and property seizure.

➤ Major Provisions:

- Till the year 2004, "unlawful" activities referred to actions related to secession and cession of territory. Following the 2004 amendment, "terrorist act" was added to the list of offences.
 - 2019 amendment, empowers the government to designate individuals as terrorists.
- The Act gives the central government complete authority to declare any activity as unlawful. If the government considers an activity unlawful, it can officially declare it so by publishing a notice in the Official Gazette.
- Under the UAPA, the investigating agency can file a charge sheet in maximum 180 days after the arrests and the duration can be extended further after intimating the court.
- Both Indian and foreign nationals can be charged. It will be applicable to the offenders in the same manner, even if crime is committed on a foreign land, outside India.
- It has the death penalty and life imprisonment as highest punishments.

NC and PDP: A Political Overview

Why in News?

The **Jammu & Kashmir Legislative Assembly elections** of 2024 have seen the **National Conference (NC)** and **Congress** alliance leading, with the **People's Democratic Party (PDP)** trailing behind.

Note:

Key Points

➤ Jammu & Kashmir National Conference (NC):

- Founded in 1932 by **Sheikh Muhammad Abdullah**.
- Emerged as a powerful political force advocating for Kashmiri rights and **land reforms**.
- After Independence, **Maharaja Hari Singh** signed the **Instrument of Accession** in 1947 amidst a Pakistani invasion.
- Sheikh Abdullah was appointed Prime Minister of an **interim government in 1948**.
- The NC won **73 of 75 seats** in the 1951 elections for the **Constituent Assembly of J&K**.
- Sheikh Abdullah was dismissed and jailed in 1953, reportedly under Prime Minister **Nehru's** orders, due to concerns over Abdullah's links with Pakistan.
- Abdullah returned to power after an accord with **Indira Gandhi** in 1975.
- Sheikh Abdullah's son, Farooq, succeeded him in 1982.
- **Militancy and the 1990s:**
 - The 1990s saw the rise of **militancy in the region**, with the NC's political dominance weakening.
- **Post-2000 Political Alliances:**
 - The NC briefly aligned with the **BJP-led NDA in 1999**.
 - Since then, NC has intermittently allied with Congress, including in the 2019 elections under the INDI Alliance.
 - Since the abrogation of **Article 370** in 2019, the NC has called for the restoration of **J&K's special status**.

➤ Peoples Democratic Party (PDP):

- Founded in 1999 by **Mufti Mohammed Sayeed** after leaving the Congress.
- Sayeed's political career started in the **Democratic National Conference**, an NC splinter group.
- Sayeed briefly served as **India's first Kashmiri Muslim Home Minister** (1989-91) in the **V P Singh government**.
- The PDP came to power in 2002 in coalition with the Congress, with Sayeed serving as CM.

○ Alliance with BJP (2014):

- In 2014, the PDP entered into an alliance with the BJP, a controversial decision given their ideological differences.
- Mufti Mohammed Sayeed passed away in 2016, and his daughter Mehbooba Mufti took over as party leader.
- The PDP, like the NC, has demanded the restoration of Article 370 since its abrogation.
- The PDP's political influence has waned in recent years, with only 3 seats won in the 2024 elections.

State Party

- A party is recognised as a state party in a state if any of the following conditions is fulfilled:
 - If it secures **6% of the valid votes polled in the state** at a general election to the respective state **legislative assembly (state LA)** and also, it wins 2 seats in the same state LA.
 - If it secures **6% of the total valid votes** in the state at a general election to the LS; and also, it wins 1 seat in the LS from the same state.
 - If it wins **3% of seats in the LA** at a general election to the legislative assembly of the state concerned or 3 seats in the assembly (whichever is more).
 - If it wins **1 seat in the LS for every 25 seats** or any fraction thereof allotted to the state at a general election to the LS from the state concerned.
 - If it secures **8% of the total valid votes polled in the state at a General Election** to the LS from the state or to the State LA.

Nominated MLAs and Potential Impact on J&K Assembly

Why in News?

Recently, as the **Jammu and Kashmir (J&K) assembly election** results draw near, the nomination of five **Members of Legislative Assembly (MLAs)** by the **Lieutenant Governor** has raised concerns about its potential influence on government formation.

Note:



Key Points

- **Nominations Before Assembly Formation:**
 - The **Lieutenant Governor of J&K** is reportedly nominating five MLAs before the formation of the assembly, raising concerns in political circles.
 - The five nominated MLAs represent Kashmiri displaced persons and those from **Pakistan-Occupied Jammu and Kashmir (POJK)**.
 - These MLAs will have full legislative powers and privileges, just like elected representatives.
- **Jammu and Kashmir Reorganisation Act, 2019:**
 - The **J&K Reorganisation Act, 2019** allows for the nomination of members to the assembly, with provisions to give representation to women.
 - A 2023 amendment to the Act expanded the nomination to include **three additional members** – two from the **Kashmiri migrant community** and one from POJK displaced persons, bringing the total to five.
- **Majority Mark Shift:**
 - The assembly's strength would expand to **95 members** if these nominations go through, raising the majority mark for government formation to **48 seats**.
- **Puducherry Assembly Model:**
 - The J&K assembly is modeled on **Puducherry's**, where nominated members have the same powers and voting rights as elected representatives.

Jammu and Kashmir Reorganisation Act, 2019

- It divided Jammu and Kashmir into 2 Union Territories of **Jammu & Kashmir and Ladakh**.
- It repealed **Article 370**, which had granted Jammu & Kashmir a unique status.
- Leh and Kargil districts were included in the Union Territory of Ladakh, while the remaining areas became part of Jammu & Kashmir.
- Five Lok Sabha seats were retained by Jammu & Kashmir, and one was transferred to Ladakh.
- **Legislature:** The seats in the Legislative Assembly will be reserved for **tribal and scheduled caste** people to keep the proportion intact of their population in the Union Territory of Jammu & Kashmir.

- The Lt. Governors can nominate **two women members for the Assembly to represent women** if women are not sufficiently represented to justify equality between men and women.
- The elected Legislative Assembly will be for **5 years, and the Lt. The Governor will summon the Assembly once every six months**.
- The Legislative Assembly has the right to pass a law for any given part of the Union Territory of J&K related to any of the matters listed in the Indian Constitutions State's List **except for the "Police" and "Public Order."**
- Any matter specified in the **Concurrent List** will be applied to Indian Union Territories. Furthermore, Parliament will have the decision-making power to create laws for Jammu Kashmir and its Union Territory.

Kashmir on the Verge of a New Era: GOC 15 Corps

Why in News?

Recently, Lt Gen Rajiv Ghai, **General Officer Commanding (GOC) 15 Corps**, reflects on the evolving security situation and development in **Kashmir**, outlining challenges and future prospects.

Key Points

- **GOC (General Officer Commanding) 15 Corps:**
 - The GOC 15 Corps is the commanding officer of the **Indian Army's Chinari Corps**, responsible for overseeing military operations in the **Kashmir Valley and parts of Jammu and Kashmir**.
 - The Corps plays a crucial role in **counter-insurgency**, border security, and maintaining peace in the region.
- **Recent Developments in Kashmir:**
 - Kashmir is at the cusp of a **"new beginning,"** with significant development and a stable security situation over the past year and a half.
 - Security forces, including **Chinari Corps, J&K Police, and CAPFs**, have worked together to maintain peace and stability.
 - No new militant recruitment in the **last 18 months**; active militant numbers have decreased to approximately 80.

Note:

- The success of a robust **counter-insurgency campaign** has reduced terrorism-related incidents significantly.
- Modern technology, including **AIOS (Automated Integrated Operating Systems)**, has been employed to prevent cross-border infiltration.
- **Challenges:**
 - Maintaining the current peaceful and stable situation remains the biggest challenge for security forces.
 - The security grid, including counter-infiltration and counter-terrorism measures, must be sustained to consolidate peace in the coming years.
- **Way Forward:**
 - **Strengthening Intelligence and Surveillance:** Enhancing real-time intelligence sharing and deploying advanced surveillance technologies will help security forces anticipate and prevent potential threats, reducing the risk of infiltration and terrorism.
 - **Community Engagement and Capacity Building:** Building trust with local communities through development initiatives, social outreach, and improved governance can foster cooperation, making counter-terrorism efforts more effective while ensuring long-term stability in the region.

Jammu & Kashmir Elections 2024

Why in News?

Jammu & Kashmir held its first assembly elections in a decade and the first since the abrogation of **Article 370** in 2019. The third and final phase concluded on **1st October, 2024**.

Key Points

- **Constituencies and Turnout Breakdown:**
 - **Kashmir Division (16 Seats):**
 - **Highest turnout: Gurez (77.96%)** has highest turnout across the Kashmir region, outpolling 37 constituencies of Jammu division also.
 - **Jammu Division (24 Seats): Highest turnout: Inderwal: 82.16%**, Padder-Nagseni: 80.67%, Shri Mata Vaishnodevi: 80.45%, Akhnoor: 79.70%, Marh and Chhamb: 79%

- **First phase voter turnout (18th September):** 61%
- **Second phase voter turnout (25th September):** 57.3%

Jammu & Kashmir Demography

- **Population Statistics (2011 Census):**
 - Total population: 12,541,302 (0.93% of India's total population).
 - Males: 6,640,662.
 - Females: 5,900,640.
 - Sex ratio: 892 females per 1,000 males (compared to the national ratio of 933).
- **Religious Composition:**
 - Muslims: 68.32%.
 - Hindus: 28.44%.
 - Sikhs: 1.87%.
 - Buddhists: 0.90%.
 - Christians: 0.28%.
 - Others: 0.01%.

Impact of Candidate's Death in Elections

Why in News?

In a significant development, a 75-year-old candidate from the **Surankote constituency** in **Poonch district** passed away just six days ahead of the results of the **Jammu & Kashmir Assembly election**.

Key Points

- **Results Awaited:** If a candidate dies after voting but before the results are declared, the election results will be awaited as usual.
- **If Another Candidate Wins:** The results will be valid, and no re-election is needed if another candidate wins after counting.
- **If the Deceased Candidate Wins:** If the deceased candidate wins, the election will be cancelled.
- **Re-Voting/By-Election:** A re-election or by-election will be held on this seat since the elected candidate cannot represent the constituency.
- **Relevant Law:** Under **Section 151A of the Representation of the People Act, 1951**, elections must be held within **6 months in such a case**.

Note:



➤ Death of a Candidate Before Voting:

- **Election Cancelled:** If a candidate dies before voting and after the nomination and withdrawal period has ended, the election on the concerned seat is cancelled.
- **New Poll Date:** A new date is set for the election in that constituency to ensure voters can choose a replacement candidate.
- **Relevant Provision:** The process is governed by the **Representation of the People Act, 1951**, ensuring that voters have the chance to elect a new candidate fairly.

Representation of the People Act, 1951

➤ Provisions:

- It regulates the **conduct of elections**.
- It specifies the **qualifications and disqualifications** for membership of the houses,
- It provides provisions to curb **corrupt practices and other offences**.
- It lays down the procedure for **settling doubts and disputes** arising out of elections.

Nalin Prabhat Appointed as J&K DGP

Why in News?

Recently, senior IPS officer Nalin Prabhat was appointed as the new **Director General of Police (DGP)** for Jammu & Kashmir.

Key Points

➤ New Appointment:

- Prabhat is a **three-time Police Gallantry Medal** winner.

- Prior to his current role, he was the **NSG** chief and held top positions in the **CRPF** in J&K, including Special DG and IG (Operations).
- He headed **Greyhounds**, an elite **anti-Naxal** unit in Andhra Pradesh.

The Greyhounds

- It is an elite anti-Maoist force raised in **1989** by **IPS officer K.S. Vyas** to combat the growing Maoist threat in Andhra Pradesh.
- The members are well-trained in guerilla and jungle warfare.

National Security Guard (NSG)

- The NSG is a **counter-terrorism unit** that formally came into existence in **1986** by an act of Parliament- '**National Security Guard Act, 1986**'.
- The idea behind raising such force came in the aftermath of **Operation Blue Star** (an Indian military action carried out to remove militant religious leader from the Golden Temple, Amritsar) in **1984**, Akshardham Temple attack and the assassination of former PM Indira Gandhi, for 'combating terrorist activities with a view to protect states against internal disturbances.'

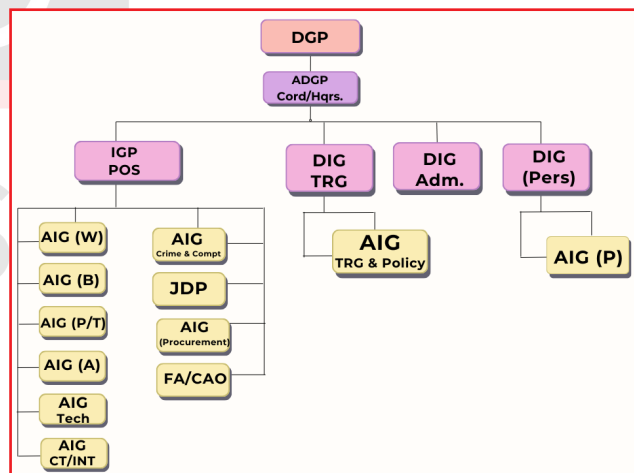

Note:

